

# 9 Cables

---

- 9.1 Ground Cable
- 9.2 PCIe Cables
- 9.3 Optical Fiber
- 9.4 Ethernet Cable
- 9.5 DC Power Cable (with OT and Cord End Terminals)
- 9.6 DC Power Cable (with Quick-Connect and Cord End Terminals)
- 9.7 2-Pin DC Power Cable (Phoenix Connector)
- 9.8 AC Power Cable
- 9.9 3-Pin AC Power Cable (Phoenix Connector)
- 9.10 Monitoring Port Cable (Phoenix Connector)
- 9.11 RPS1800 Power Cable
- 9.12 RPS Cable
- 9.13 Console Cable
- 9.14 Dedicated Stack Cable
- 9.15 Copper Cable
- 9.16 Lead-Acid Battery Temperature Sensor
- 9.17 First-Generation Hybrid Cable
- 9.18 Second-Generation Hybrid Cable

## 9.1 Ground Cable

### Appearance and Structure

**Figure 9-1** shows the appearance of a typical ground cable.

**NOTE**

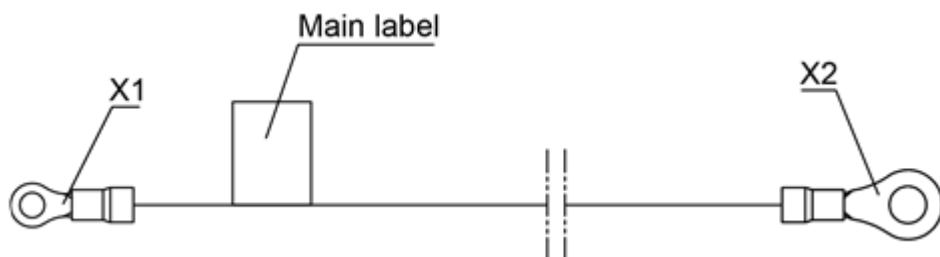
Other types of ground cables are similar to the example shown in the figure, except for their cross-sectional area, size of the cable lugs, and cable length.

**Figure 9-1** Appearance of a ground cable



**Figure 9-2** shows the structure of a ground cable.

**Figure 9-2** Structure of a ground cable



## Pin Assignments

**Table 9-1** lists the pin assignments of a ground cable.

**Table 9-1** Pin assignments of a ground cable

| X1   | X2   | Wire Color   | Conductor Cross-Sectional Area | Length |
|------|------|--------------|--------------------------------|--------|
| OT-4 | OT-6 | Green-yellow | 4 mm <sup>2</sup>              | 0.4 m  |

## Connection

A ground cable grounds a device to protect it from lightning and electromagnetic interference. A ground cable is connected to a chassis in the following way:

- The OT-4 naked crimping connector connects to the ground point on the chassis.
- The OT-6 naked crimping connector connects to the ground point on the cabinet.

## 9.2 PCIe Cables

### Appearance and Structure

The S5700 series switches can use PCIe cables as stack cables to connect stack ports on rear stack cards. Switches connected using stack cables form a logical switch to forward packets.

**Figure 9-3** shows the appearance of a PCIe cable.

**Figure 9-3** PCIe cable



#### NOTE

Both ends of a PCIe cable must be covered by an ESD cap.

## Specifications

**Table 9-2** Specifications of a PCIe cable

| Attribute                | Description  |   |
|--------------------------|--|---|
| Cable model              | 1 m PCIe cable   | 3 m PCIe cable<br><b>NOTE</b><br>This cable is available in V200R002C00 and later versions.   |
| Connector type           | PCIe   |   |
| Standards compliance     | PCIe 8X  |   |
| Length                   | 1.0 m  | 3.0 m   |
| Applicable device models | <ul style="list-style-type: none"><li>• S5700-SI</li><li>• S5700-EI</li><li>• S5710-C-LI</li></ul> | <ul style="list-style-type: none"><li>• V200R002C00: S5700-52C-EI and S5700-28C-EI-24S</li><li>• V200R003C00 and later versions:<ul style="list-style-type: none"><li>– S5700-SI</li><li>– S5700-EI</li></ul></li></ul> |

## 9.3 Optical Fiber

### Active Optical Cable

An active optical cable (AOC) is an optical fiber with optical modules at both ends, making it easy to use.

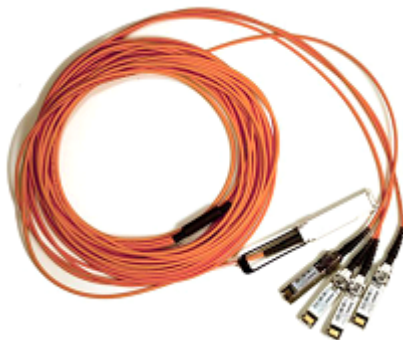
**Figure 9-4** SFP+ to SFP+ or SFP28 to SFP28 AOC cable



**Figure 9-5** QSFP+ to QSFP+ or QSFP28 to QSFP28 AOC cable



**Figure 9-6** QSFP+ to 4\*SFP+ AOC cable



**Table 9-3** lists the models and attributes of AOC cables.

**Table 9-3** Attributes of AOC cables

| Model              | Length | Bend Radius | Connector Type   | Part Number | Operating Temperature |
|--------------------|--------|-------------|--|-------------|-----------------------|
| SFP-10G-AOC3M      | 3 m    | 30 mm       | SFP+ connectors at both ends   | 02310QWG    | 0°C to 70°C           |
| SFP-10G-AOC10M     | 10 m   | 30 mm       | SFP+ connectors at both ends   | 02310QWH    | 0°C to 70°C           |
| QSFP-H40G-AOC10M   | 10 m   | 25 mm       | QSFP+ connectors at both ends  | 02310SSH    | 0°C to 70°C           |
| QSFP-4SFP10-AOC10M | 10 m   | 25 mm       | QSFP+ connector at one end and four SFP+ connectors at the other end | 02310SSJ    | 0°C to 70°C           |
| QSFP-100G-AOC-10M  | 10 m   | 25 mm       | QSFP28 connectors at both ends                                       | 02311KNQ    | 0°C to 70°C           |
| SFP-25G-AOC-3M     | 3 m    | 30 mm       | SFP28 connectors at both ends  | 02311MPE    | 0°C to 70°C           |
| SFP-25G-AOC-5M     | 5 m    | 30 mm       | SFP28 connectors at both ends  | 02311MPD    | 0°C to 70°C           |
| SFP-25G-AOC-7M     | 7 m    | 30 mm       | SFP28 connectors at both ends  | 02311MPC    | 0°C to 70°C           |
| SFP-25G-AOC-10M    | 10 m   | 30 mm       | SFP28 connectors at both ends  | 02311KNT    | 0°C to 70°C           |

## Fiber Jumper

A fiber jumper consists of one or more fibers of a certain length and the optical connectors at both ends. A fiber jumper connects an optical module to a fiber terminal box.

### NOTE

- The MPO-MPO and MPO-2\*MPO fibers have similar appearances except for the number of MPO connectors at the other end. The following figures show an MPO-MPO fiber for example.
- The MPO-4\*DLC and MPO-10\*DLC fibers have similar appearances except for the number of DLC connectors at the other end.
- The MPO-MPO fibers for S series switches use type B connectors (key Up/key Up).

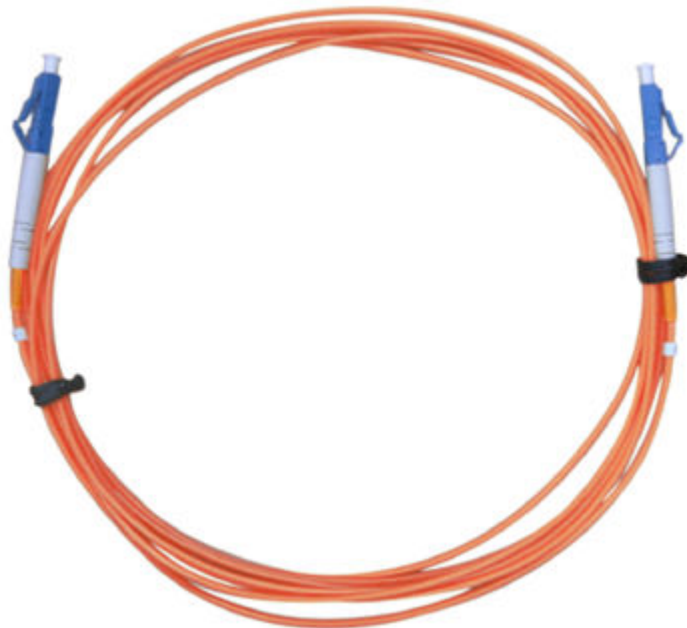
**Figure 9-7** shows a single-mode LC/PC fiber jumper.

**Figure 9-7** Single-mode LC/PC fiber jumper



**Figure 9-8** shows a multimode LC/PC fiber jumper.

**Figure 9-8** Multimode LC/PC fiber jumper



**Figure 9-9** shows a single-mode SC/PC fiber jumper.

**Figure 9-9** Single-mode SC/PC fiber jumper



**Figure 9-10** shows an MPO-MPO fiber jumper.

**Figure 9-10** MPO-MPO fiber jumper



**Figure 9-11** shows an MPO-4\*DLC fiber jumper.

**Figure 9-11** MPO-4\*DLC fiber jumper





**Figure 9-12** shows an MPO-10\*DLC fiber jumper.

**Figure 9-12** MPO-10\*DLC fiber jumper

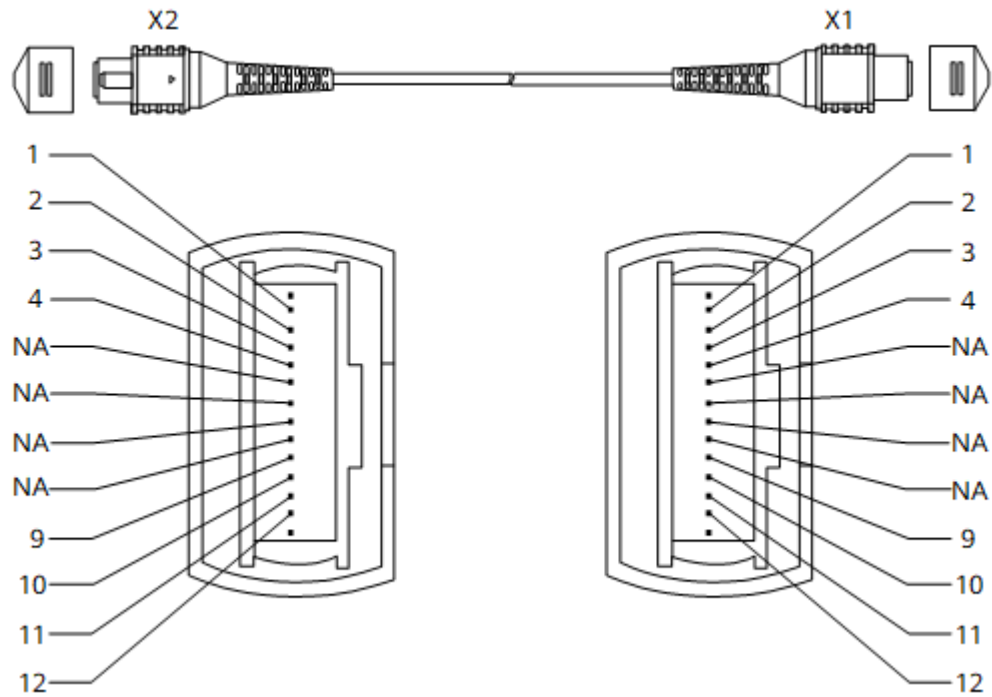


Comply with the following rules when selecting fiber jumpers:

1. Determine the length of fiber jumpers based on the onsite cabling distance.
2. Determine the fiber type based on the optical module type.
  - Use a multimode fiber jumper for a multimode optical module.
  - Use a single-mode fiber jumper for a single-mode optical module.
3. Determine the optical connector type based on the interface type.  
Ensure that the optical connector at each end of a fiber jumper is the same type as the interface to which it will be connected.

**Figure 9-13** shows the structure of an 8-strand MPO-MPO fiber jumper.

**Figure 9-13** Structure of an 8-strand MPO-MPO fiber jumper



**Figure 9-14** shows the structure of a 12-strand MPO-MPO fiber jumper.

**Figure 9-14** Structure of a 12-strand MPO-MPO fiber jumper

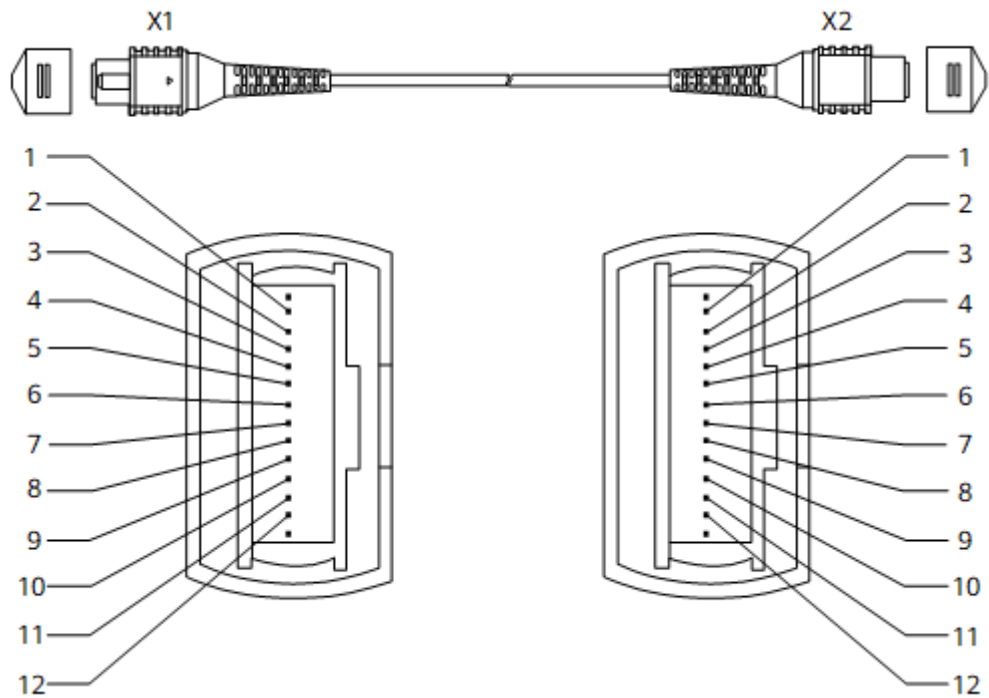


Figure 9-15 shows the structure of a 24-strand MPO-MPO fiber jumper.

Figure 9-15 Structure of a 24-strand MPO-MPO fiber jumper

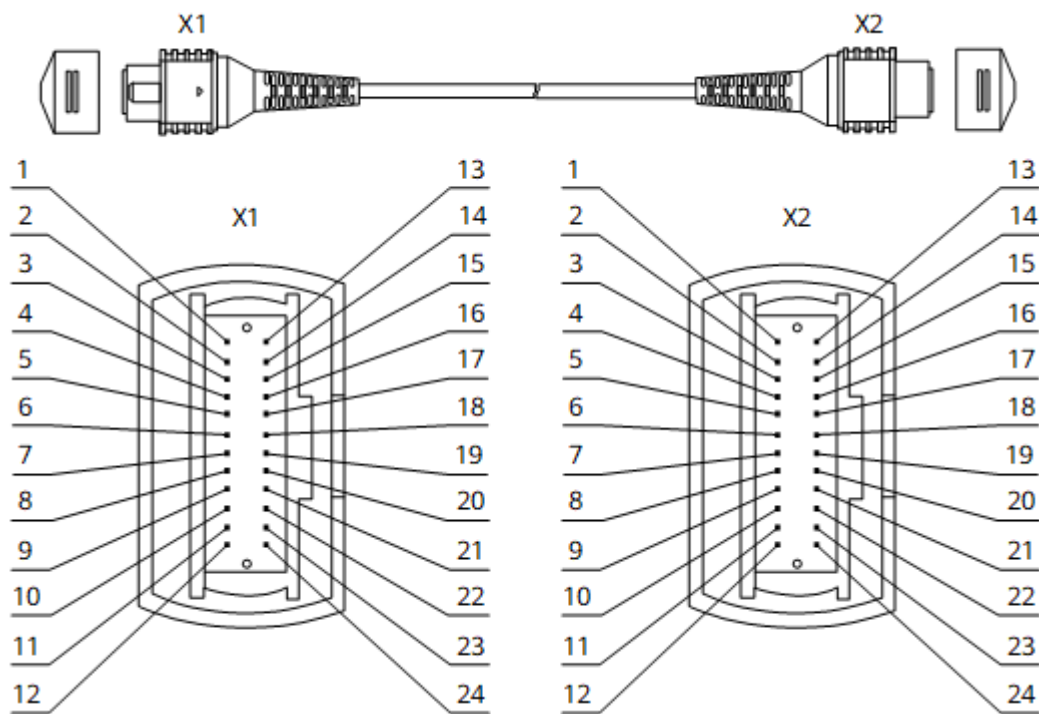
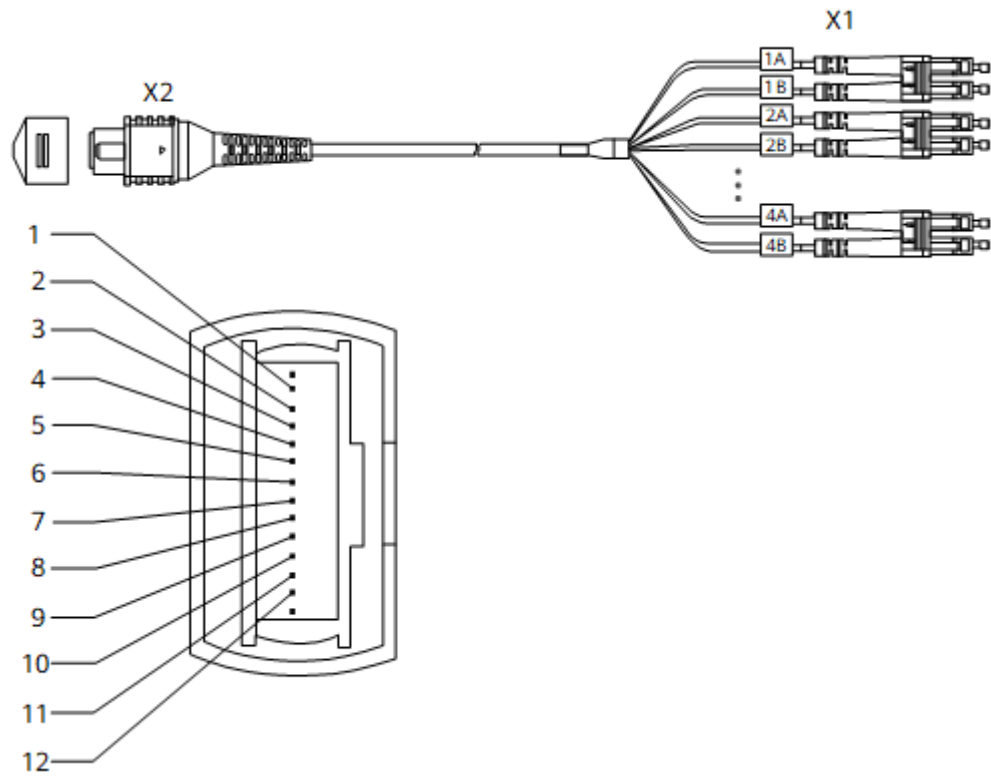


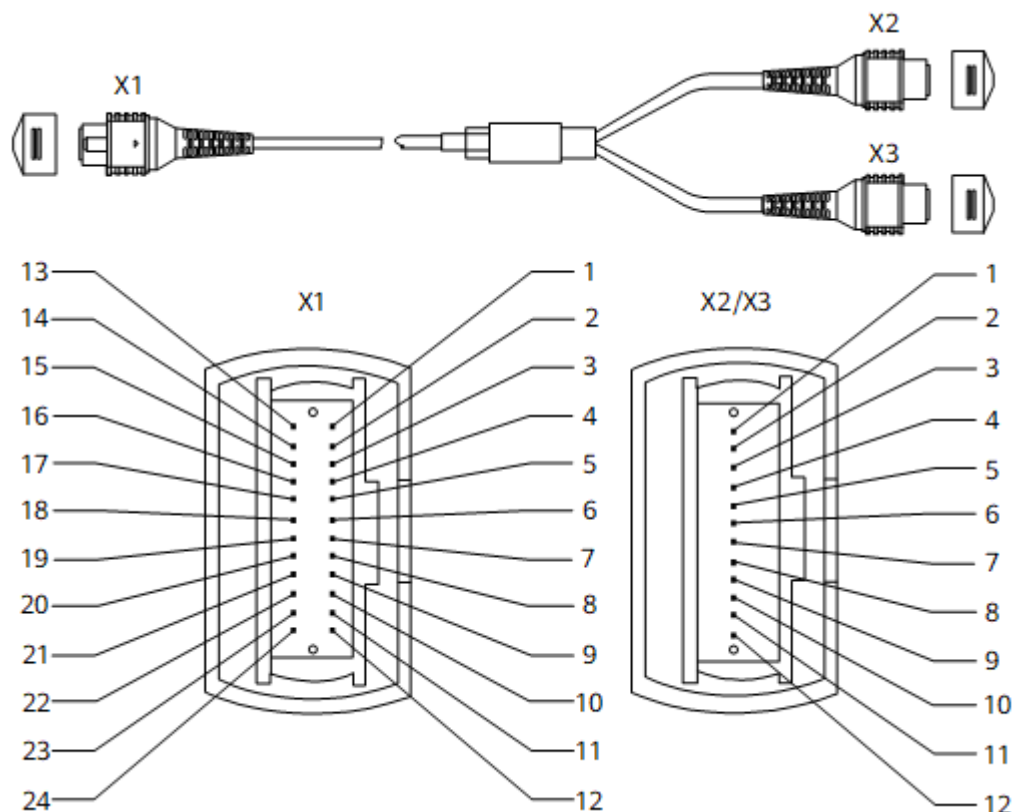
Figure 9-16 shows the structure of an MPO-4\*DLC fiber jumper.

**Figure 9-16** Structure of an MPO-4\*DLC fiber jumper



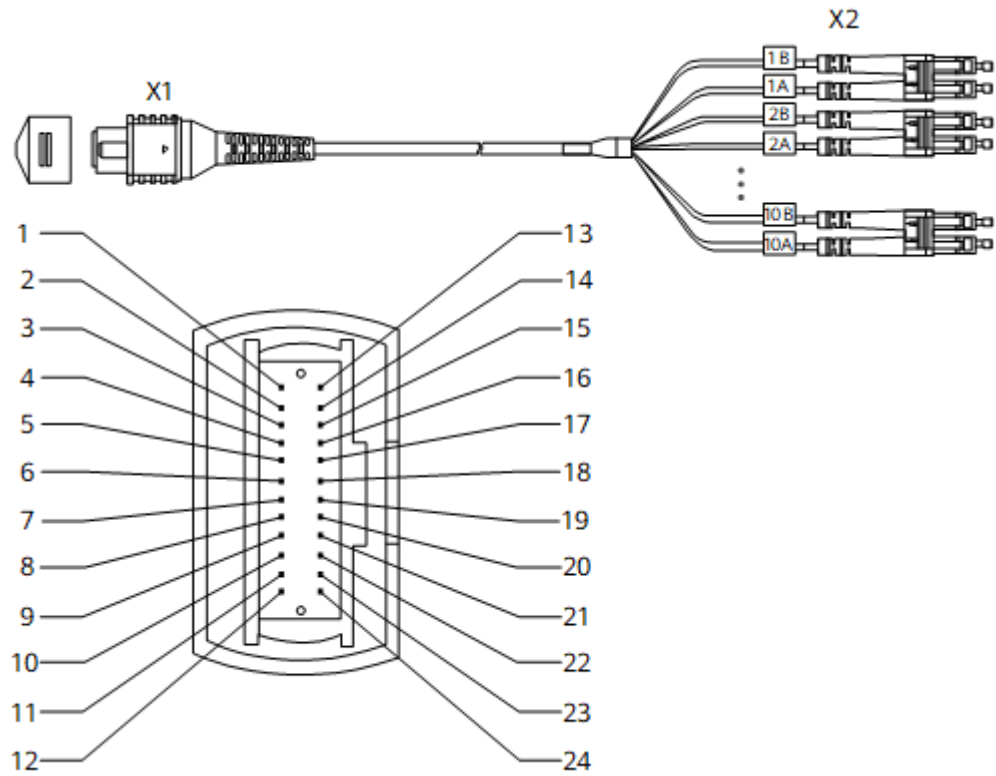
**Figure 9-17** shows the structure of an MPO-2\*MPO fiber jumper.

**Figure 9-17** Structure of an MPO-2\*MPO fiber jumper



**Figure 9-18** shows the structure of an MPO-10\*DLC fiber jumper.

**Figure 9-18** Structure of an MPO-10\*DLC fiber jumper



**Table 9-4** lists the pin assignments of an 8-strand MPO-MPO fiber jumper.

**Table 9-4** Pin assignments of an 8-strand MPO-MPO fiber jumper

| X1 Pin | X2 Pin |
|--------|--------|
| 1      | 12     |
| 2      | 11     |
| 3      | 10     |
| 4      | 9      |
| NA     | NA     |
| NA     | NA     |
| NA     | NA     |
| NA     | NA     |
| 9      | 4      |
| 10     | 3      |
| 11     | 2      |

| X1 Pin | X2 Pin |
|--------|--------|
| 12     | 1      |

**Table 9-5** lists the pin assignments of a 12-strand MPO-MPO fiber jumper.

**Table 9-5** Pin assignments of a 12-strand MPO-MPO fiber jumper

| X1 Pin | X2 Pin |
|--------|--------|
| 1      | 12     |
| 2      | 11     |
| 3      | 10     |
| 4      | 9      |
| 5      | 8      |
| 6      | 7      |
| 7      | 6      |
| 8      | 5      |
| 9      | 4      |
| 10     | 3      |
| 11     | 2      |
| 12     | 1      |

**Table 9-6** lists the pin assignments of a 24-strand MPO-MPO fiber jumper.

**Table 9-6** Pin assignments of a 24-strand MPO-MPO fiber jumper

| X1 Pin | X2 Pin | X1 Pin | X2 Pin |
|--------|--------|--------|--------|
| 1      | 24     | 13     | 12     |
| 2      | 23     | 14     | 11     |
| 3      | 22     | 15     | 10     |
| 4      | 21     | 16     | 9      |
| 5      | 20     | 17     | 8      |
| 6      | 19     | 18     | 7      |
| 7      | 18     | 19     | 6      |

| X1 Pin | X2 Pin | X1 Pin | X2 Pin |
|--------|--------|--------|--------|
| 8      | 17     | 20     | 5      |
| 9      | 16     | 21     | 4      |
| 10     | 15     | 22     | 3      |
| 11     | 14     | 23     | 2      |
| 12     | 13     | 24     | 1      |

**Table 9-7** lists the pin assignments of an MPO-4\*DLC fiber jumper.

**Table 9-7** Pin assignments of an MPO-4\*DLC fiber jumper

| X2 Pin | X1 Pin |
|--------|--------|
| 1      | 1A     |
| 2      | 2A     |
| 3      | 3A     |
| 4      | 4A     |
| 9      | 4B     |
| 10     | 3B     |
| 11     | 2B     |
| 12     | 1B     |

**Table 9-8** lists the pin assignments of an MPO-2\*MPO fiber jumper.

**Table 9-8** Pin assignments of an MPO-2\*MPO fiber jumper

| X1 Pin | X2 Pin | X3 Pin |
|--------|--------|--------|
| 2      | 12     | NA     |
| 3      | 11     | NA     |
| 4      | 10     | NA     |
| 5      | 9      | NA     |
| 7      | NA     | 12     |
| 8      | NA     | 11     |
| 9      | NA     | 10     |



| X1 Pin | X2 Pin | X3 Pin |
|--------|--------|--------|
| 10     | NA     | 9      |
| 14     | 1      | NA     |
| 15     | 2      | NA     |
| 16     | 3      | NA     |
| 17     | 4      | NA     |
| 19     | NA     | 1      |
| 20     | NA     | 2      |
| 21     | NA     | 3      |
| 22     | NA     | 4      |

**Table 9-9** lists the pin assignments of an MPO-10\*DLC fiber jumper.

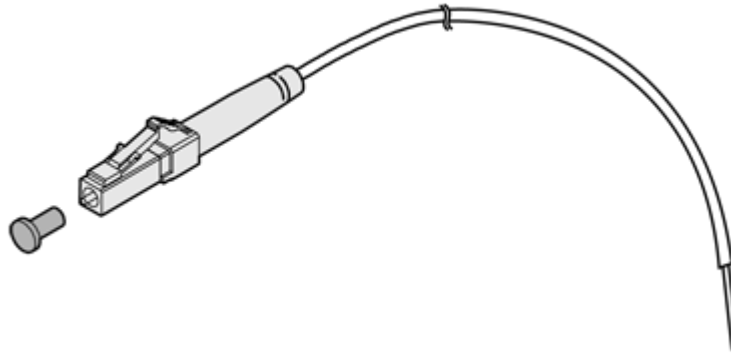
**Table 9-9** Pin assignments of an MPO-10\*DLC fiber jumper

| X1 Pin | X2 Pin | X1 Pin | X2 Pin |
|--------|--------|--------|--------|
| 2      | 1A     | 14     | 1B     |
| 3      | 2A     | 15     | 2B     |
| 4      | 3A     | 16     | 3B     |
| 5      | 4A     | 17     | 4B     |
| 6      | 5A     | 18     | 5B     |
| 7      | 6A     | 19     | 6B     |
| 8      | 7A     | 20     | 7B     |
| 9      | 8A     | 21     | 8B     |
| 10     | 9A     | 22     | 9B     |
| 11     | 10A    | 23     | 10B    |

## Fiber Pigtail

A fiber pigtail is an optical fiber that has an optical connector on one end and a piece of exposed fiber at the other end. The exposed fiber can be fused to another optical fiber. Fiber pigtails are commonly used to connect optical fibers to optical modules in fiber terminal boxes (couplers and jumpers are also used). **Figure 9-19** shows the structure of a fiber pigtail.

**Figure 9-19** Structure of a fiber pigtail



Fiber pigtails are classified into single-mode and multimode fiber pigtails and are used for short-distance connections.

## Optical Fiber, Optical Connector, and Fiber Adapter

### Optical Fibers

Optical fibers are classified into single-mode fibers and multimode fibers.

- Single-mode fibers have a diameter of 5-10  $\mu\text{m}$  and transmit laser in one mode under a specified wavelength. These fibers support a wide frequency band and a large transmission capacity, so they are used for long-distance transmission. Most single-mode fibers are yellow, as shown in [Figure 9-7](#).
- Multimode fibers have a diameter of 50  $\mu\text{m}$  or 62.5  $\mu\text{m}$  and transmit laser light in multiple modes under a specified wavelength. These fibers have a lower transmission capacity than single-mode fibers and are used for short-distance transmission. Modal dispersion occurs during transmission over multimode fibers.

In the latest cabling infrastructure of ISO/IEC 11801, multimode fibers are classified into four categories: OM1, OM2, OM3, and OM4.

- OM1: traditional 62.5/125  $\mu\text{m}$  multimode fibers. OM1 fibers have a large core diameter and numerical aperture, and provide high light gathering ability and bending resistance.
- OM2: traditional 50/125  $\mu\text{m}$  multimode fibers. OM2 fibers have a small core diameter and numerical aperture. Compared with OM1 fibers, OM2 fibers provide higher bandwidth because they significantly reduce the modal dispersion. When transmitting data at 1 Gbit/s with 850 nm wavelength, OM1 and OM2 fibers support maximum link lengths of 220 m and 550 m, respectively. OM1 and OM2 fibers can provide sufficient bandwidth within a distance of 300 m. Generally, OM1 and OM2 fibers are orange, as shown in [Figure 9-8](#).
- OM3: new-generation multimode fibers, with longer transmission distances than OM1 and OM2 fibers.
- OM4: laser optimized multimode fibers with 50  $\mu\text{m}$  core diameter. OM4 is an improvement to OM3 and only increases the modal bandwidth. OM4 fibers provide 4700 MHz\*km of modal bandwidth, whereas OM3 fibers provide only 2000 MHz\*km of modal bandwidth. Generally, OM3

and OM4 fibers are light green. You can identify OM3 and OM4 fibers by their labels or printed marks.







MPO fibers are used for 40G and 100G optical modules. An MPO fiber consists of multiple multi-mode fiber strands, and each multi-mode fiber strand provides one laser transmission channel. Some fiber suppliers produce 8-strand MPO optical fibers, while some suppliers produce 12-strand or 24-strand MPO fibers.

- A 40G optical module uses four channels to transmit laser and four channels to receive laser. That is, a total of eight channels are required for a 40G optical module. 8-strand and 12-strand MPO fibers use the same definition of fiber channels. Therefore, they are equivalent in functionality when connecting to 40G optical modules.
- When 100G optical modules are used, choose MPO fibers according to the following rules:
  - For CFP optical modules, choose 24-strand fibers for the CFP-100G-SR10 module and 8-strand or 12-strand fibers for other modules.
  - Choose 8-strand or 12-strand fibers for QSFP28 modules.

### Optical Connector

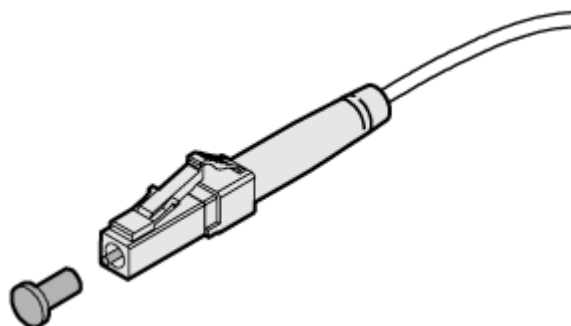
Optical connectors are used to connect optical fibers of the same type. [Table 9-10](#) lists common optical connectors.

**Table 9-10** Common optical connectors

| Connect or Type  | Optical Connector  |  |   |  |
|------------------|--|--|---|--|
| Square connector | SC/PC connector<br> | LC/PC connector<br> | MTRJ/PC connector<br> | MPO connector<br> |
| Round connector  | FC/PC connector<br> | ST/PC connector<br> | -   | -  |

[Figure 9-20](#) shows an LC/PC optical connector.

**Figure 9-20** LC/PC optical connector



---

#### NOTICE

When connecting or removing an LC/PC optical connector, align the connector with the optical port and do not rotate the fiber. Pay attention to the following points:

- To connect a fiber, align the optical connector with the optical port and gently insert the optical fiber into the port.
  - To remove a fiber, press the clip on the connector and pull the fiber out.
- 

#### Fiber Adapter

A fiber adapter (also called a flange) is a fiber connection component. Two fiber connectors need to be connected using a fiber adapter. Fiber adapters are widely used in optical distribution frames (ODFs), fiber transmission equipment, and optical instruments.

## 9.4 Ethernet Cable

### Types of Ethernet Cables

An Ethernet cable connects a maintenance terminal to the console port on the device for local or remote maintenance.

Ethernet cables are classified into straight-through cables and crossover cables.

- Straight-through cable: The twisted pairs in the RJ45 connectors at both ends are crimped in the same sequence. A straight-through cable connects two devices of different types, for example, a PC and a switch.
- Crossover cable: The twisted pairs in the RJ45 connectors at two ends are crimped in different sequences. A crossover cable connects two devices or interfaces of the same type, for example, two PCs.

Crossover and straight cables only differ in wire sequences, and function the same when transmitting data.

Huawei switches support both straight-through and crossover cables and their ports are adaptive to the cable types.

Use shielded Ethernet cables when switches complying with EN 50121-4 are used in environments that meet EN 50121-4 requirements.

### Appearance and Structure

#### NOTE

The straight-through cable and the crossover cable have the same appearance and use the RJ45 connector.

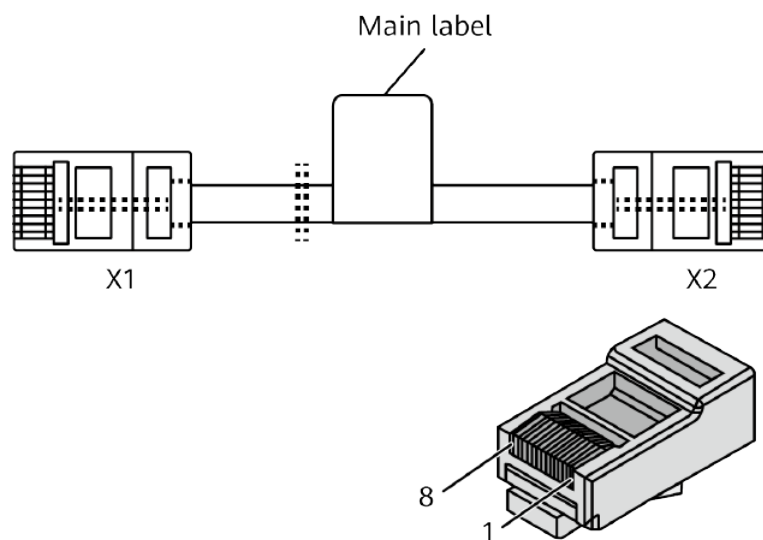
**Figure 9-21** shows the appearance of an Ethernet cable.

**Figure 9-21** Appearance of an Ethernet cable



**Figure 9-22** shows the structure of an Ethernet cable.

**Figure 9-22** Structure of an Ethernet cable



## Pin Assignments

**Table 9-11** lists pin assignments of a straight-through cable.

**Table 9-11** Pin assignments of a straight-through cable

| Connector X1 | Connector X2 | Color        | Relationship |
|--------------|--------------|--------------|--------------|
| X1.2         | X2.2         | Orange       | Twisted pair |
| X1.1         | X2.1         | White/Orange |              |
| X1.6         | X2.6         | Green        | Twisted pair |
| X1.3         | X2.3         | White/Green  |              |
| X1.4         | X2.4         | Blue         | Twisted pair |
| X1.5         | X2.5         | White/Blue   |              |
| X1.8         | X2.8         | Brown        | Twisted pair |
| X1.7         | X2.7         | White/Brown  |              |

**Table 9-12** lists pin assignments of a crossover cable.

**Table 9-12** Pin assignments of a crossover cable

| Connector X1 | Connector X2 | Color        | Relationship |
|--------------|--------------|--------------|--------------|
| X1.6         | X2.2         | Orange       | Twisted pair |
| X1.3         | X2.1         | White/Orange |              |
| X1.2         | X2.6         | Green        | Twisted pair |
| X1.1         | X2.3         | White/Green  |              |
| X1.4         | X2.4         | Blue         | Twisted pair |
| X1.5         | X2.5         | White/Blue   |              |
| X1.8         | X2.8         | Brown        | Twisted pair |
| X1.7         | X2.7         | White/Brown  |              |

 **NOTE**

To achieve the best electrical transmission performance, ensure that the wires connected to pins 1 and 2 and to pins 3 and 6 are twisted pairs.

## 9.5 DC Power Cable (with OT and Cord End Terminals)

## Types of DC Power Cables

DC power cables include a -48 V power return cable and a -48 V power cable. The -48 V power return cable is connected to a terminal marked RTN (+), and the -48 V power cable is connected to a terminal marked NEG (-).

## Appearance and Structure

[Figure 9-23](#) and [Figure 9-24](#) show the appearance and structure of the -48 V power return cable and -48 V power cable.

**Figure 9-23** Appearance of a -48 V power return cable



**Figure 9-24** Appearance of a -48 V power cable



**NOTE**

A -48 V power return cable is black and is connected to the RTN(+) terminal of the DC power supply. A -48 V power cable is blue and is connected to the NEG(-) terminal of the DC power supply.

## Connection

A DC power cable (with OT and cord end terminals) is connected to a DC power module with OT terminals as follows:

- The OT terminal is connected to the input port on the DC power module of the device.
- The cord end terminal is connected to an external power module.

## 9.6 DC Power Cable (with Quick-Connect and Cord End Terminals)

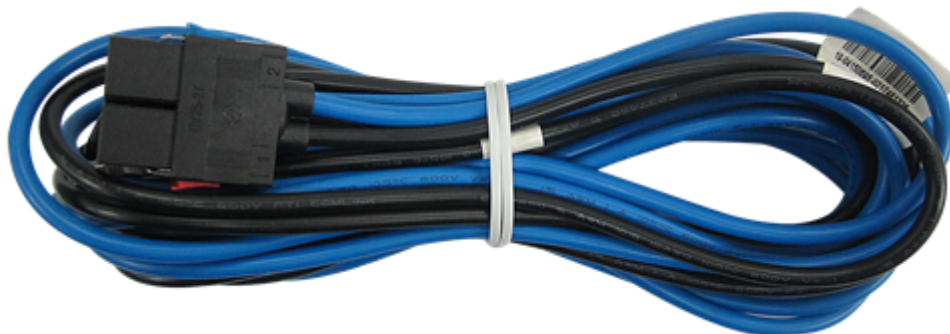
### Appearance and Structure

DC power cables consist of the power cable for a 350 W/650 W DC power module and the power cable for a 1000 W DC power module.

**Figure 9-25** shows the appearance of the power cable for a 350 W/650 W DC power module.

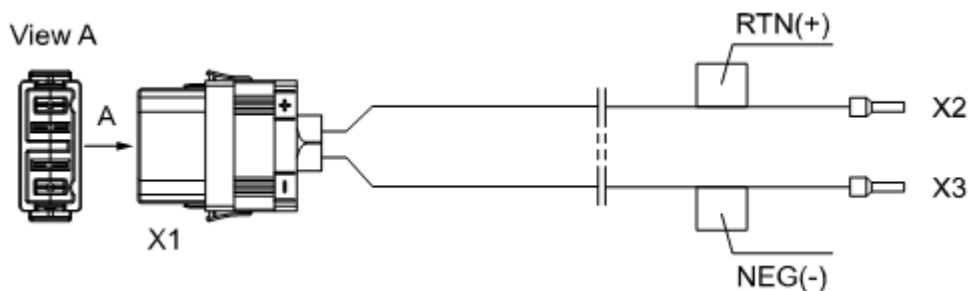


**Figure 9-25** Appearance of the power cable for a 350 W/650 W DC power module



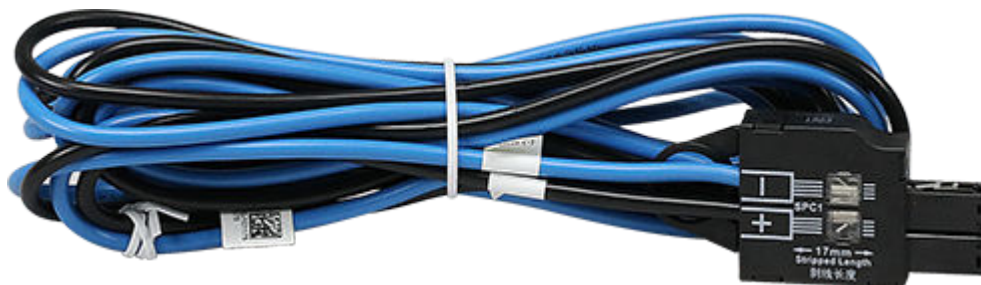
**Figure 9-26** shows the structure of the power cable for a 350 W/650 W DC power module.

**Figure 9-26** Structure of the power cable for a 350 W/650 W DC power module



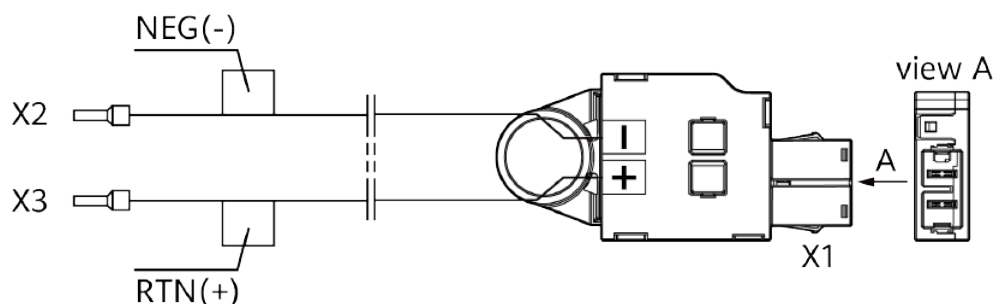
**Figure 9-27** shows the appearance of the power cable for a 1000 W DC power module.

**Figure 9-27** Appearance of the power cable for a 1000 W DC power module



**Figure 9-28** shows the structure of the power cable for a 1000 W DC power module.

**Figure 9-28** Structure of the power cable for a 1000 W DC power module



## Pin Assignments

**Table 9-13** lists the pin assignments of the power cable for a 350 W/650 W DC power module.

**Table 9-13** Pin assignments of the power cable for a 350 W/650 W DC power module

| X1       | X2                                    | X3                                    | Length | Conductor Cross-Sectional Area |
|----------|---------------------------------------|---------------------------------------|--------|--------------------------------|
| 2 female | Cord end terminal 4 <sup>2</sup> gray | Cord end terminal 4 <sup>2</sup> gray | 3 m    | 3.332 mm <sup>2</sup> (12AWG)  |

**Table 9-14** lists the pin assignments of the power cable for a 1000 W DC power module.

**Table 9-14** Pin assignments of the power cable for a 1000 W DC power module

| X1       | X2                                    | X3                                    | Length | Conductor Cross-Sectional Area |
|----------|---------------------------------------|---------------------------------------|--------|--------------------------------|
| 2 female | Cord end terminal 4 <sup>2</sup> gray | Cord end terminal 4 <sup>2</sup> gray | 3 m    | 4 mm <sup>2</sup> (14AWG)      |

## Connection

A DC power cable connects to the DC power module of the device:

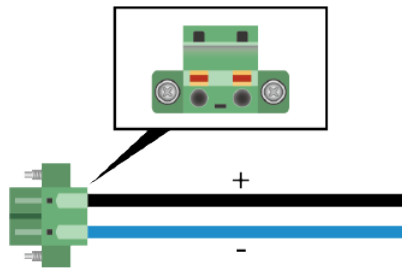
- X1 connector connects to the input port on the DC power module.
- X2/X3 cord end terminal connects to an external power module.

## 9.7 2-Pin DC Power Cable (Phoenix Connector)

### Appearance and Structure

**Figure 9-29** shows the appearance and structure of the 2-pin DC power cable and the Phoenix connector.

**Figure 9-29** Structure of a 2-pin DC power cable and Phoenix connector



### Specifications

**Table 9-15** lists the specifications of the 2-pin DC power cable.

**Table 9-15** Specifications of a 2-pin DC power cable

| Minimum Conductor Cross-Sectional Area (for the Power Cable Delivered with the Switch) | Maximum Conductor Cross-Sectional Area |
|--|--|
| 0.75 mm <sup>2</sup> or 18 AWG   | 3 mm <sup>2</sup> or 12 AWG            |

### Connection

One end of the 2-pin DC power cable is used with the Phoenix connector and connected to the DC input port of the S5720I-SI. The other end needs to be made onsite. You can make the power cables according to site requirements and connect the cables to the DC power supply system.

## 9.8 AC Power Cable

## Appearance and Structure

**Figure 9-30** C13 straight female to PI straight male AC power cable (used in China)



**Figure 9-31** C7 straight female to PG curving male AC power cable (used in Britain)



**Figure 9-32** C13 straight female to C14 straight male AC power cable (China)



**NOTE**

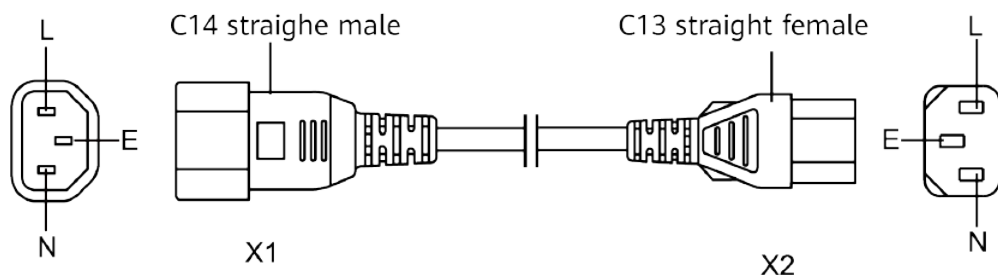
The AC power cables used in different countries and regions have different connector types. [Figure 9-30](#) and [Figure 9-31](#) use Chinese and Britain AC power cables as examples. The power cable and plug delivered with the chassis can only be used on this chassis, and cannot be used on other devices.

## Types of AC Power Cables

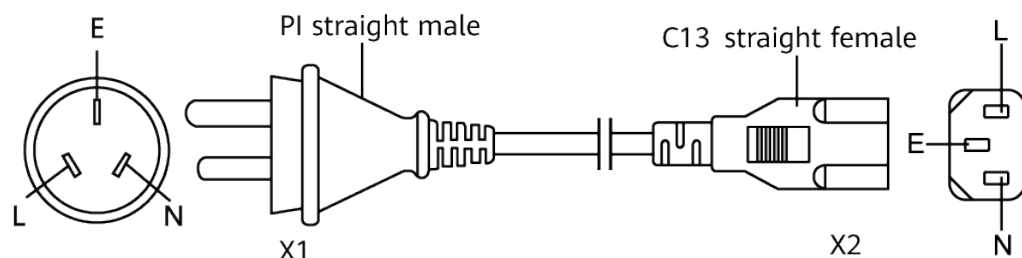
Select AC power cables based on the power supply system in your equipment room. Standard and country-specific AC power cables can be directly connected to power modules.

- Standard power cables: used to transmit power from a PDU. [Figure 9-33](#) shows the structure of a C14 straight male to C13 straight female AC power cable.
- Country-specific power cables: used to transmit power from a country-specific power strip. The cables are delivered in compliance with standards of the destination country or region. For example, PI straight male to C13 straight female AC power cable ([Figure 9-34](#)) is used in China.
- The AC power cables connected to a power distribution box must have cord end terminals. [Figure 9-35](#) shows the structure of a cord end to C13 straight female AC power cable.

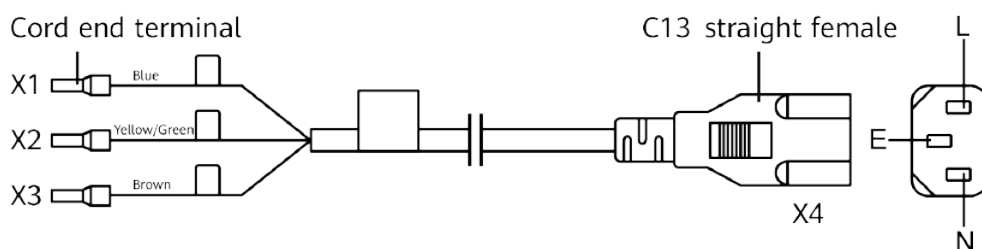
**Figure 9-33** Structure of a C14 straight male to C13 straight female AC power cable



**Figure 9-34** Structure of a PI straight male to C13 straight female AC power cable (used in China)



**Figure 9-35** Structure of a Cord end to C13 straight female AC power cable (used in China)



## Connection

**Table 9-16** shows connections of various AC power cables.

**Table 9-16** Connections of AC power cables

| Power Cable Type   | Connector Type and Connection  |   |
|--|--|---|
| C14 straight male to C13 straight female AC power cable                | C14 straight male connector:<br>connected to a PDU                         | C13 straight female connector:<br>connected to the AC power socket on the switch. |
| PI straight male to C13 straight female AC power cable (used in China) | PI straight male connector:<br>connected to a country-specific power strip | The current rating of the power cable is 10 A.                                    |

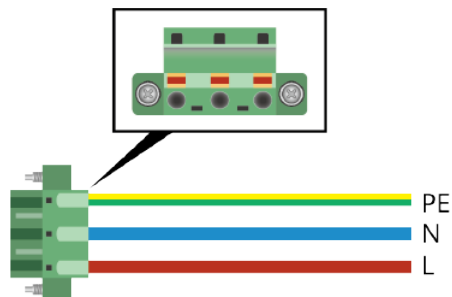
| Power Cable Type   | Connector Type and Connection  |  |
|--|--|--|
| Cord end to C13 straight female AC power cable (used in China)         | Cord end terminal: connected to a power distribution box or power distribution frame.<br>Connect the brown wire to the L terminal, blue wire to the N terminal, and the yellow/green wire to the ground terminal.<br>Different AC power cables may be delivered in compliance with local regulations or customer requirements. |  |
| C7 straight female to PG curving male AC power cable (used in Britain) | PG curving male connector: connected to a country-specific power strip   | C7 straight female connector: connected to the power input port on the power adapter.<br><b>NOTE</b><br>The power adapters of the S5735-L8P4S-QA1, S5731-L, and S5731S-L use C7 straight female AC power cables. |

## 9.9 3-Pin AC Power Cable (Phoenix Connector)

## Appearance and Structure

Figure 9-36 shows the appearance and structure of the 3-pin AC power cable and the Phoenix connector.

Figure 9-36 Structure of a 3-pin AC power cable and Phoenix connector



### **⚠ DANGER**

There is a risk of electric shock when handling the Phoenix connector. To avoid electric shock, ensure that wires are connected in the following sequences: red wire (live wire) connects to L; blue wire (neutral wire) connects to N; yellow/green wire (ground cable) connects to PE. In special circumstances, comply with local regulations or customer requirements.

The power cable and Phoenix connector need to be connected onsite. Ensure that there are no exposed metal parts after the power cable is connected to the Phoenix connector.

## Specifications

Table 9-17 lists the specifications of the 3-pin AC power cable.

Table 9-17 Specifications of a 3-pin AC power cable

| Minimum Conductor Cross-Sectional Area (for the Power Cable Delivered with the Switch)  | Maximum Conductor Cross-Sectional Area |
|---|--|
| 0.75 mm <sup>2</sup> or 18 AWG<br><b>NOTE</b><br>The minimum conductor cross-sectional area for the S5720I-28X-PWH-SI-AC series switches is 1.25 mm <sup>2</sup> or 16 AWG. | 3 mm <sup>2</sup> or 12 AWG            |

## Connection

One end of the 3-pin AC power cable is used with the Phoenix connector and connected to the AC input port of the S5720I-SI. The other end needs to be made



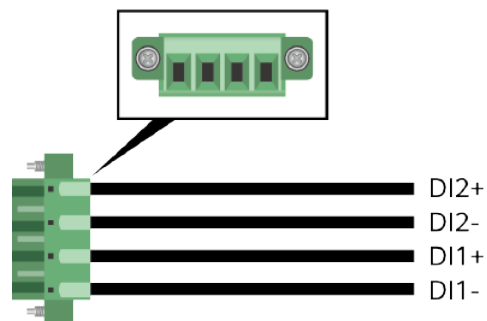
onsite. You can make the power cables according to site requirements and connect the cables to the AC power supply system.

## 9.10 Monitoring Port Cable (Phoenix Connector)

### Appearance and Structure

**Figure 9-37** shows the structure of the monitoring port cable and the Phoenix connector.

**Figure 9-37** Structure of a monitoring port cable and Phoenix connector



The monitoring ports provide two input lines, which can be used to monitor two types of devices that support output voltage monitoring. DI1+ is the input high level of line 1 and DI1- is the input low level of line 1. Similarly, DI2+ is the input high level of line 2 and DI2- is the input low level of line 2.

### Specifications

The monitoring port must be used with the Phoenix connector (included in the installation accessory package) and the monitoring port cable (purchased separately). The monitoring port cable must be a conductive cable. **Table 9-18** lists the specifications of the monitoring port cable.

**Table 9-18** Specifications of a monitoring port cable

| Minimum Conductor Cross-Sectional Area | Maximum Conductor Cross-Sectional Area |
|--|--|
| 0.08 mm <sup>2</sup> or 28 AWG         | 1.5 mm <sup>2</sup> or 16 AWG          |

### Connection

One end of the monitoring port cable is used with the Phoenix connector and connected to the monitoring port of the S5720I-SI. The other end needs to be made onsite. You can make the power cables according to site requirements and connect the cables to external devices to be monitored.

## 9.11 RPS1800 Power Cable

### Appearance and Structure

[Figure 9-38](#) shows the appearance of the RPS1800 AC power cable.

**Figure 9-38** Appearance of the RPS1800 AC power cable



#### NOTE

The PRS AC power cable used by the RPS1800 has the same appearance as a common AC power cable. However, the RPS AC power cable and common AC power cable connect to different connectors.

### Connection

An RPS1800 AC power cable connects to the following:

- An AC power input port on the RPS1800 chassis
- The mains supply

## 9.12 RPS Cable

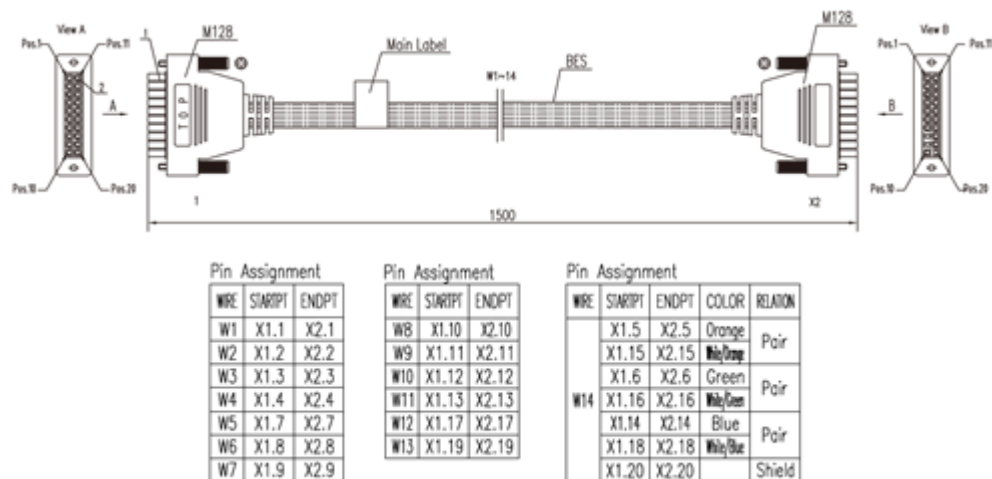
### Appearance and Structure

[Figure 9-39](#) and [Figure 9-40](#) show the appearance and structure of an RPS cable.

**Figure 9-39** Appearance of an RPS cable



**Figure 9-40** Structure of an RPS cable



## Connection

An RPS cable connects an RPS1800 power module to a switch so that the RPS1800 provides power to the switch. An RPS power cable connects to the following:

- A DC power output port on the RPS1800 chassis
- A switch to which power is provided

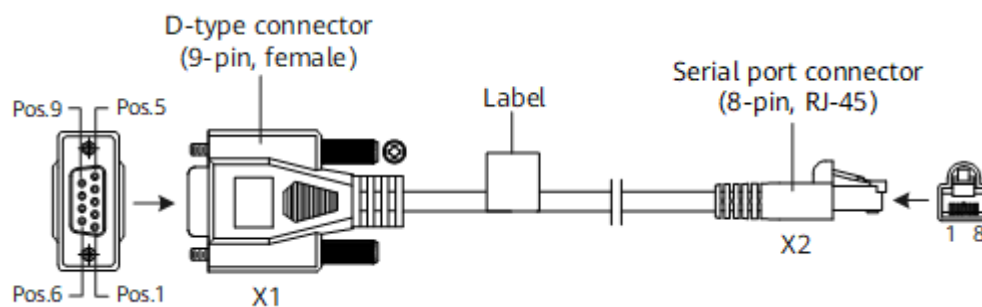
## 9.13 Console Cable

### Appearance and Structure

[Figure 9-41](#) and [Figure 9-42](#) show the appearance and structure of a console cable.

**Figure 9-41** Appearance of a console cable



**Figure 9-42** Structure of a console cable

## Pin Assignments

**Table 9-19** lists the pin assignments of console cable connectors.

**Table 9-19** Pin assignments of console cable connectors

| Connector      | X1 (DB9) | X2 (RJ45) |
|----------------|----------|-----------|
| Pin assignment | 2        | 3         |
|                | 3        | 6         |
|                | 5        | 5         |

## Connection

A console cable connects the console port of the device to the serial port of an operation terminal to transmit configuration data. A shielded cable or an unshielded cable can be used according to the onsite situation.

A console cable connects the device and terminal as follows:

- The 8-pin RJ45 connector is inserted into the console port of the device.
- The DB9 connector is inserted into the terminal serial port.

## 9.14 Dedicated Stack Cable

### Types of Dedicated Stack Cables

**Table 9-20** lists the applicable dedicated stack cables.

**Table 9-20** Dedicated stack cables

| Model          | Length | Electrical Attribute | Bend Radius | Connector Type   | Part Number |
|----------------|--------|----------------------|-------------|------------------|-------------|
| SFP-10G-CU0M5  | 0.5 m  | Passive              | 25 mm       | SFP+ to SFP+     | 02311VGK    |
| SFP-10G-CU1M5  | 1.5 m  | Passive              | 25 mm       | SFP+ to SFP+     | 02311VGN    |
| QSFP-100G-CU2M | 2 m    | Passive              | 45 mm       | QSFP28 to QSFP28 | 02313HVK    |

## Appearance and Structure

**Figure 9-43** Dedicated stack cable appearance



The two ends of a dedicated stack cable are the master end with the Master tag and the slave end without any tag. The device connected to the master end of a dedicated stack cable assumes the master role and the device connected to the slave end assumes the slave role only after you perform operations as required.

**Figure 9-44** shows the structure of a dedicated stack cable.

**Figure 9-44** Dedicated stack cable structure



## Stack Setup

Dedicated stack cables can only be used to connect the same sub-series switch models, enabling them to set up a stack without manual configuration.

Before setting up a stack, confirm the stack connection mode supported by the member switches, as well as the hardware and software requirements. For details, see "Determining the Stack Connection Support and Mode" under "Typical Stack Configuration of Fixed Switches" in the *Typical Configuration Examples*.

## 9.15 Copper Cable

### Types of Copper Cables

[Table 9-21](#) shows the types of copper cables.

**Table 9-21** Types of copper cables

| Model             | Length | Electrical attribute | Bend Radius | Connector Type  | Part Number |
|-------------------|--------|----------------------|-------------|-----------------|-------------|
| SFP-10G-CU1M      | 1 m    | Passive              | 25 mm       | SFP+ to SFP+    | 02310MUN    |
| SFP-10G-CU2M      | 2 m    | Passive              | 25 mm       | SFP+ to SFP+    | 02311JFJ    |
| SFP-10G-CU3M      | 3 m    | Passive              | 25 mm       | SFP+ to SFP+    | 02310MUP    |
| SFP-10G-CU5M      | 5 m    | Passive              | 30 mm       | SFP+ to SFP+    | 02310QPR    |
| SFP-10G-AC10M     | 10 m   | Active               | 25 mm       | SFP+ to SFP+    | 02310MUQ    |
| QSFP-40G-CU1M     | 1 m    | Passive              | 35 mm       | QSFP+ to QSFP+  | 02310MUG    |
| QSFP-40G-CU3M     | 3 m    | Passive              | 40 mm       | QSFP+ to QSFP+  | 02310MUH    |
| QSFP-40G-CU5M     | 5 m    | Passive              | 45 mm       | QSFP+ to QSFP+  | 02310MUJ    |
| QSFP-4SFP10G-CU1M | 1 m    | Passive              | 25 mm       | QSFP+ to 4*SFP+ | 02310MUK    |
| QSFP-4SFP10G-CU3M | 3 m    | Passive              | 25 mm       | QSFP+ to 4*SFP+ | 02310MUL    |
| QSFP-4SFP10G-CU5M | 5 m    | Passive              | 30 mm       | QSFP+ to 4*SFP+ | 02310MUM    |

| Model            | Length | Electrical attribute | Bend Radius | Connector Type   | Part Number |
|------------------|--------|----------------------|-------------|------------------|-------------|
| QSFP28-100G-CU1M | 1 m    | Passive              | 70 mm       | QSFP28 to QSFP28 | 02311KNW    |
| QSFP28-100G-CU3M | 3 m    | Passive              | 70 mm       | QSFP28 to QSFP28 | 02311KNX    |
| QSFP28-100G-CU5M | 5 m    | Passive              | 70 mm       | QSFP28 to QSFP28 | 02311KNY    |
| SFP-25G-CU1M     | 1 m    | Passive              | 35 mm       | SFP28 to SFP28   | 02311NKS    |
| SFP-25G-CU3M     | 3 m    | Passive              | 35 mm       | SFP28 to SFP28   | 02311NKV    |
| SFP-25G-CU3M-N   | 3 m    | Passive              | 40 mm       | SFP28 to SFP28   | 02311MNV    |
| SFP-25G-CU5M     | 5 m    | Passive              | 40 mm       | SFP28 to SFP28   | 02311MNW    |

#### NOTICE

The two ends of a copper cable must be covered by electrostatic discharge (ESD) caps.

When used for data transmission between service ports, copper cables can connect Huawei switches of the same subseries. AOC optical cables or optical modules can be used to connect to all Huawei switches.

- The SFP-10G-CU1M and SFP-10G-CU2M copper cable can connect the S6730-H28Y4C or S6730-H24X4Y4C to the S5700-28C-HI-24S (used the LS5D00X4SA00 card), S5720-28X-LI-AC, S5720-28X-LI-24S-AC, S5720-28X-LI-24S-DC, S5700-28X-LI-24S-AC, S5700-28X-LI-24S-DC, S5700-28X-LI-AC, and S5701-28X-LI-24S-AC.
- The SFP-10G-CU2M can only be used for interconnection between the preceding devices.

## Appearance and Structure

**Figure 9-45** shows the appearance of an SFP/SFP+/SFP28 copper cable.

**Figure 9-45** Appearance of an SFP/SFP+/SFP28 copper cable



**Figure 9-46** shows the appearance of a QSFP+/QSFP28 copper cable.

**Figure 9-46** Appearance of a QSFP+/QSFP28 copper cable



**Figure 9-47** shows the appearance of a QSFP+ to 4\*SFP+ copper cable.

**Figure 9-47** Appearance of a QSFP+ to 4\*SFP+ copper cable



**Figure 9-48** shows the structure of an SFP/SFP+/SFP28 copper cable.

**Figure 9-48** Structure of an SFP/SFP+/SFP28 copper cable

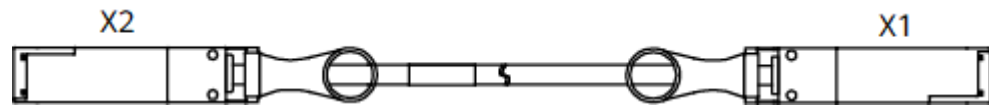


**Figure 9-49** shows the structure of a QSFP+/QSFP28 copper cable.

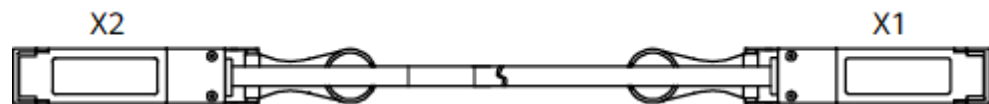


**Figure 9-49** Structure of a QSFP+/QSFP28 copper cable

Front view:

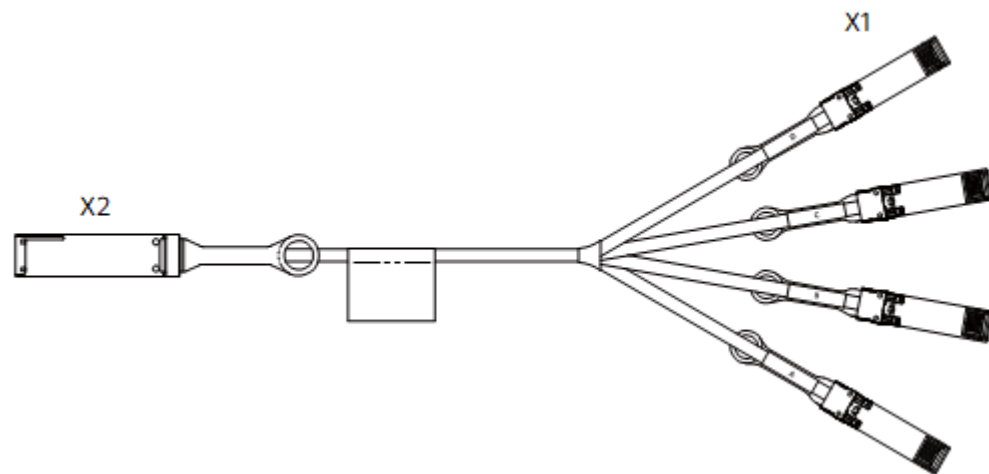


Rear view:



**Figure 9-50** shows the structure of a QSFP+ to 4\*SFP+ copper cable.

**Figure 9-50** Structure of a QSFP+ to 4\*SFP+ copper cable



## Stack Description

In addition to data transmission, copper cables can be used for stack connection.

Before setting up a stack, familiarize yourself with the device-supported stack connection modes and software and hardware requirements. For details, see "Determining the Stack Connection Support and Mode" under "Typical Stack Configuration of Fixed Switches" in the *Typical Configuration Examples*.

## 9.16 Lead-Acid Battery Temperature Sensor

A lead-acid battery temperature sensor monitors ambient temperature of a lead-acid battery in real time to provide charge temperature compensation.

 NOTE

Due to the negative temperature feature of a lead-acid battery, the charge voltage must be adjusted based on the ambient temperature. The battery charger must provide higher charge voltage when the temperature is low and provide lower charge voltage when the temperature is high, so that the lead-acid battery can be fully charged. The PBB-12AHA module can control the charge voltage for the lead-acid battery based on the temperature collected by the temperature sensor. Using a temperature sensor can prolong the life time of the lead-acid battery.

## Appearance and Structure

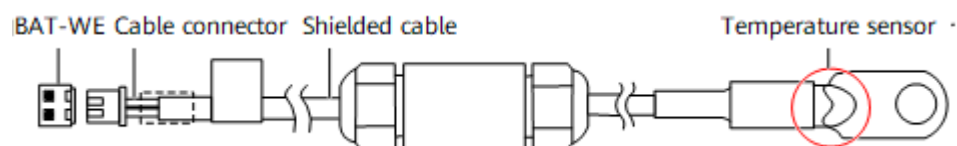
**Figure 9-51** shows the appearance of a lead-acid battery temperature sensor.

**Figure 9-51** Appearance of a lead-acid battery temperature sensor



**Figure 9-52** shows the structure of a lead-acid battery temperature sensor.

**Figure 9-52** Structure of a lead-acid battery temperature sensor



## Connection

Follow these instructions when using a lead-acid battery temperature sensor:

- Connect the cable connector to the SENSOR port on the PBB-12AHA lead-acid battery charger module.
- Place the temperature probe (with an OT terminal) where it can collect the most accurate ambient temperature of the lead-acid battery. You are advised to place the temperature probe near the lead-acid battery and bind the sensor cable with the power cables of the lead-acid battery. Do not connect the temperature probe to any other heating device. Hang the temperature probe in air and keep it away from any heating device.

## 9.17 First-Generation Hybrid Cable

### Overview

The first-generation hybrid cable (hybrid cable 1.0) is composed of optical fibers and copper cores. It is mainly used to connect an S5732-H48XUM2CC switch to an AP or a remote unit so that the switch can supply PoE power and transmit data to the AP or remote unit.

The first-generation hybrid cables must be made onsite using the purchased bare wires, auxiliary material packages that contain RJ45 connectors, and auxiliary material packages used for mechanical or fusion splicing of optical fibers. [Table 9-22](#) lists the bare wires and auxiliary material packages.

**Table 9-22** Bare wires and auxiliary material packages

| Type      | Description   | Applicable Country /Region                             | Optical Fiber/ Connector Type | Part Number  |
|-----------|---|--|-------------------------------|--------------|
| Bare wire | hybrid cable, 1.5mm <sup>2</sup> ,2mm*1.6mm, Indoor,GDVV-2G.657A2(Bow-type )+2x1.5mm <sup>2</sup> (RV),500V,Blue, Black,2 cores,Single mode,9/125       | Southeast Asia, Africa, and other countries or regions | Single-mode, G.657A2          | 25090017     |
| Bare wire | hybrid cable, 1.5mm <sup>2</sup> ,2mm*1.6mm, Indoor,GDVV-2G.657A2(Bow-type )+2x1.5mm <sup>2</sup> (RV),500V,Red,Blue,2 cores,Single mode,9/125          | China  | Single-mode, G.657A2          | 25090017-001 |
| Bare wire | hybrid cable, 1.5mm <sup>2</sup> ,2mm*1.6mm, Indoor,LSZH,GDHH-2G.657A2(Bow-type )+2x1.5mm <sup>2</sup> (H07Z-K),450V,Red,Blue,2 cores,Single mode,9/125 | China  | Single-mode, G.657A2          | 25090018-002 |

| Type   | Description   | Applicable Country /Region                  | Optical Fiber/ Connector Type | Part Number |
|--|---|---|-------------------------------|-------------|
| Bare wire  | hybrid cable, 1.5mm <sup>2</sup> ,2mm*1.6mm, Indoor,LSZH,For Europe,GDHH-2G.657A2(Bow-type )+2x1.5mm <sup>2</sup> (H07Z-K), 450V,Brown,Blue,2 cores,Single mode,9/125 | Europe                                      | Single-mode, G.657A2          | 25090018    |
| Auxiliary material package containing RJ45 connectors                          | MPE Site Materials Kit,Photoelectric Hybrid Cable installation Material Package about DC PoE RJ45   | Worldwide, used to terminate copper cores   | RJ45                          | 02233FKX    |
| Auxiliary material package for mechanical splicing of optical fibers           | MPE Site Materials Kit,Photoelectric Hybrid Cable installation Material Package about LC mechanical splicing at both side,Fast Mountable-Mechanical-LC/UPC            | Worldwide, used to terminate optical fibers | LC/UPC                        | 02233FKY    |
| Auxiliary material package for mechanical or fusion splicing of optical fibers | MPE Site Materials Kit,Photoelectric Hybrid Cable installation Material Package about LC mechanical splicing and Fiber splicing                                       | Worldwide, used to terminate optical fibers | LC/UPC                        | 02233FLA    |
| Auxiliary material package for fusion splicing of optical fibers               | MPE Site Materials Kit,Photoelectric Hybrid Cable installation Material Package about Fiber splicing at both side   | Worldwide, used to terminate optical fibers | -                             | 02233FLB    |

**CAUTION**

Bare wires are delivered by country or region where hybrid cables are used. The difference predominantly lies in the color of copper cores.

The first-generation hybrid cables can only be used indoors and cannot be connected to outdoor APs.

The first-generation hybrid cables cannot be connected through a cable distribution frame.

Copper cores in the first-generation hybrid cable must be directly connected to a switch and an AP.

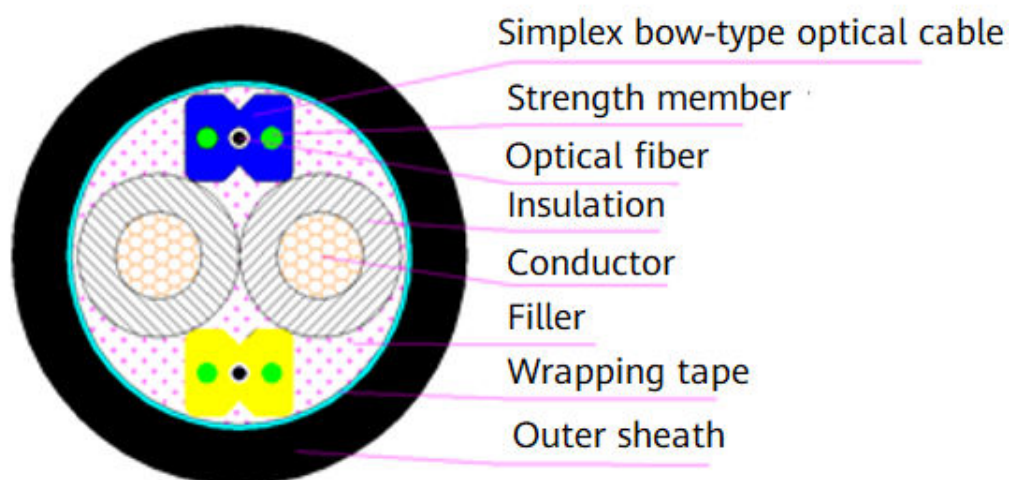
The connected ports cannot go up if a switch and an AP are connected only through copper cores in the first-generation hybrid cable.

It is recommended that optical fibers in the first-generation hybrid cables be fusion spliced onsite. If you assemble optical fibers in hybrid cables in mechanical splicing mode, only SFP-10G-iLR-S optical modules are supported.

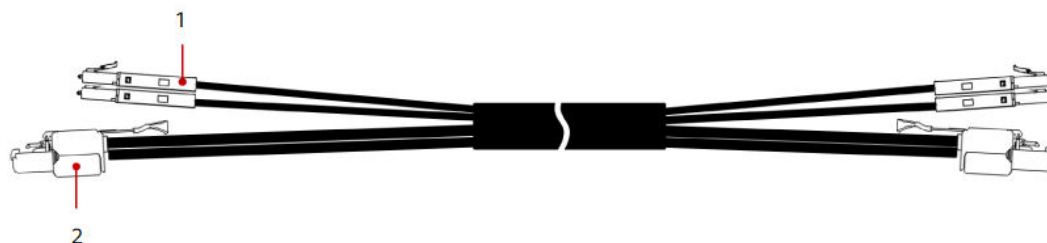
## Appearance and Structure

Figure 9-53, Figure 9-54, and Figure 9-55 show the appearance and structure of the first-generation hybrid cable.

Figure 9-53 Cross section of the first-generation hybrid cable



**Figure 9-54** Structure of the first-generation hybrid cable



|                 |                   |
|-----------------|-------------------|
| 1. LC connector | 2. RJ45 connector |
|-----------------|-------------------|

**Figure 9-55** Appearance of the first-generation hybrid cable



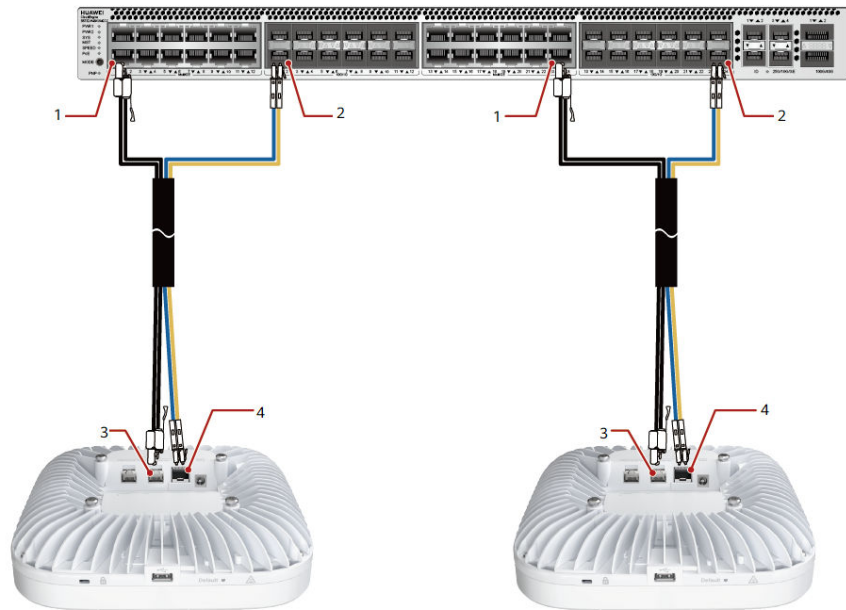
## Cable Connection

The first-generation hybrid cable is typically used in the following scenario:

- The copper cores connect a multi-GE port of a switch to a PoE\_IN port of an AP to allow the switch to supply power to the AP while no data is transmitted over this cable.
- The optical fibers connect an SFP+ port on the switch to an SFP+ port of the AP to transmit data.

**Figure 9-56** shows how the first-generation hybrid cable connects a switch to an AP.

**Figure 9-56** Connections of the first-generation hybrid cable



|                              |                                      |
|------------------------------|--------------------------------------|
| 1. Multi-GE port on a switch | 2. 10GE/GE SFP+ port on a switch     |
| 3. PoE_IN port on an AP      | 4. Uplink 10GE/GE SFP+ port on an AP |

**NOTE**

Connectors at two ends of each optical fiber in a hybrid cable must be connected to the TX and RX ports on optical modules, one end to a TX port and the other end to an RX port.

Optical fibers in all hybrid cables must be connected according to the same rules. [Table 9-23](#) provides the recommended connection rules.

**Table 9-23** Recommended optical fiber connections

| Optical Fiber Color | Optical Module on a Switch | Optical Module on an AP |
|---------------------|----------------------------|-------------------------|
| Blue                | TX                         | RX                      |
| Yellow              | RX                         | TX                      |

## 9.18 Second-Generation Hybrid Cable

## Overview

The second-generation hybrid cable (hybrid cable 2.0) is composed of optical fibers and copper cores. It is mainly used to connect a hybrid optical-electrical switch to an AP so that the switch can provide power and transmit data for the AP.

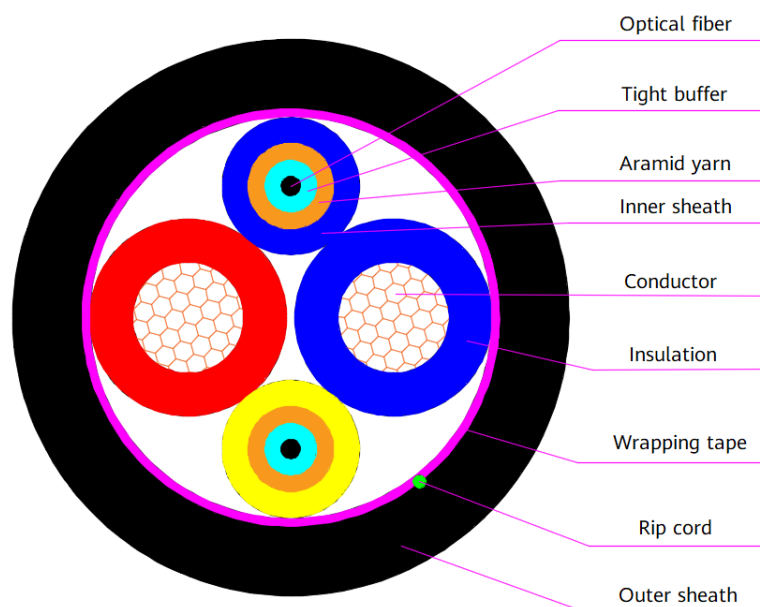
Differences between the first-generation hybrid cable and second-generation hybrid cable:

- Cross-sectional area of the main cable:
  - First-generation hybrid cable: 1.5 mm<sup>2</sup>
  - Second-generation hybrid cable: 17 AWG (1.04 mm<sup>2</sup>) or 21 AWG (0.41 mm<sup>2</sup>)
- Number of occupied device ports and type of the connector used on the port:
  - To connect the first-generation hybrid cable to a device, we need to connect the optical fibers with LC connectors to the common commercial optical module on the device's optical port and connect the copper wires with an RJ45 connector to the device's electrical port. The optical port is used for data transmission, while the electrical port is used for PoE power supply.
  - To connect the second-generation hybrid cable to a device, we only need to insert the PDLC connector on one end of the cable into the hybrid optical-electrical optical module on a hybrid optical-electrical port of the device. This port can be used for data transmission and PoE power supply at the same time.

Note that the pigtail or fiber jumper that can be fusion spliced to the main cable of the second-generation hybrid cable can also be fusion spliced to the main cable of the first-generation hybrid cable.

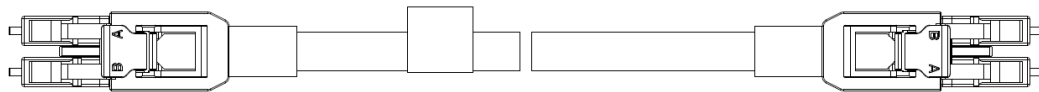
## Appearance and Structure

Figure 9-57 Cross section of a hybrid cable 2.0





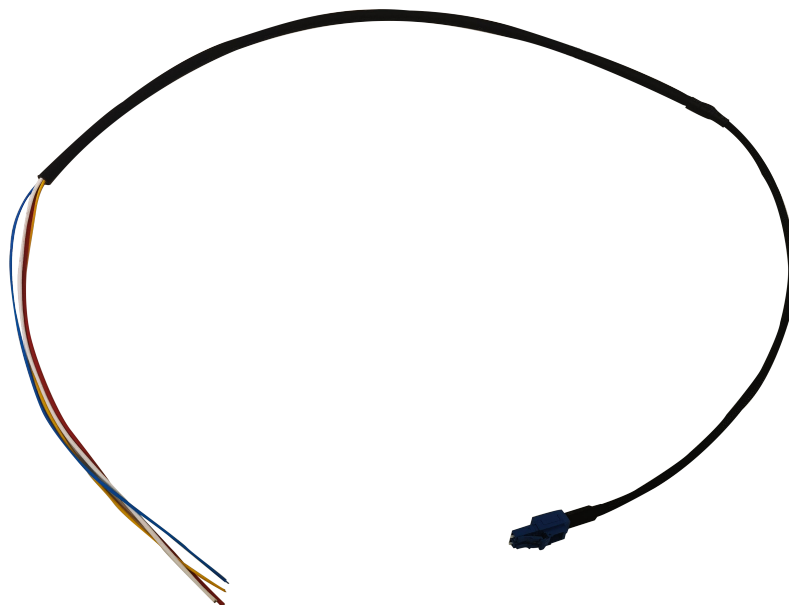
**Figure 9-58** Structure of a hybrid cable 2.0



**Figure 9-59** Appearance of a main cable



**Figure 9-60** Appearance of a pigtail



**Figure 9-61** Appearance of a 1 m jumper



## Cable Connection

A hybrid cable 2.0 is typically used in the following scenario:

- Direct connection scenario: One end of a hybrid cable 2.0 connects to a hybrid optical-electrical port of a switch, and the other end connects to a hybrid optical-electrical port of an AP, as shown in [Figure 9-62](#).
- HDF-based connection: Connect one end of the jumper to the hybrid optical-electrical port of the switch and the other end to the hybrid optical-electrical port of the HDF. Connect one end of the hybrid cable 2.0 to the hybrid optical-electrical port of the HDF and the other end to the hybrid optical-electrical port of the AP, as shown in [Figure 9-63](#).

**Figure 9-62** Direct connection

**Figure 9-63** HDF-based connection

### NOTE

- The connector of a hybrid cable 2.0 cannot be inserted into a common optical module and must be used with a hybrid module (SFP-GE-Hybrid or SFP-10G-Hybrid).
- Connectors at two ends of each optical fiber in a hybrid cable 2.0 must be connected to the TX and RX ports on optical modules, one end to a TX port and the other end to an RX port.
- The hybrid optical-electrical switch uses hybrid cables 2.0 to connect to and supply power to APs of specific models. (For details about the AP models to which hybrid cables can supply power, see the WLAN AP product documentation.)
- The hybrid optical-electrical switch cannot be connected to devices other than APs using hybrid cables 2.0.
- Optical fibers in all hybrid cables 2.0 must be connected according to the same rules. [Table 9-24](#) provides the recommended connection rules.

**Table 9-24** Recommended optical fiber connections

| Optical Fiber Color | Optical Module on a Switch | Optical Module on an AP |
|---------------------|----------------------------|-------------------------|
| Blue                | TX                         | RX                      |
| Yellow              | RX                         | TX                      |

## Technical Specifications

**Table 9-25** Technical specifications of the hybrid cable 2.0 and its components

| Type       | Part Number  | Model                  | Description  | Connector Type | Length | Flame Resistance Rating   | Bend Radius | Operating Temperature | Applicable Country/Region                     |
|------------|--------------|------------------------|--|----------------|--------|---------------------------|-------------|-----------------------|---|
| Main cable | 25090103     | HYC-GDFJVV-17AWG-RB-SM | hybrid cable,Indoor,PVC,Black,GDFJVV-2G. 657A2+2*17AWG(UL1569),17AWG,Red,Blue Sub-power cable, 1.6mm,6.2mm, 2cores,Single mode, 9/125    | -              | -      | IEC 60332-1, ZC, CPR: Eca | 31mm        | -20°C to 75°C         | China   |
|            | 25090103-001 | HYC-GDFJVV-17AWG-BB-SM | hybrid cable,Indoor,PVC,Black,GDFJVV-2G. 657A2+2*17AWG(UL1569), 17AWG,Black,Blue Sub-power cable, 1.6mm,6.2mm, 2cores,Single mode, 9/125 | -              | -      | IEC 60332-1, ZC, CPR: Eca | 31mm        | -20°C to 75°C         | Southeast Asia and other countries or regions |

| Type | Part Number  | Model                  | Description  | Connector Type | Length | Flame Resistance Rating  | Bend Radius | Operating Temperature | Applicable Country/Region                     |
|------|--------------|------------------------|--|----------------|--------|--|-------------|-----------------------|---|
|      | 25090104     | HYC-GDFJVV-21AWG-RB-SM | hybrid cable,Indoor,PVC,Black,GDFJVV-2G. 657A2+2*21AWG(UL1569),21AWG,Red,Blue Sub-power cable, 1.6mm,5.7mm, 2cores,Single mode, 9/125    | -              | -      | IEC 60332-1, ZC, CPR: Eca                                      | 28.5mm      | -20°C to 75°C         | China   |
|      | 25090104-001 | HYC-GDFJVV-21AWG-BB-SM | hybrid cable,Indoor,PVC,Black,GDFJVV-2G. 657A2+2*21AWG(UL1569), 21AWG,Black,Blue Sub-power cable, 1.6mm,5.7mm, 2cores,Single mode, 9/125 | -              | -      | IEC 60332-1, ZC, CPR: Eca                                      | 28.5mm      | -20°C to 75°C         | Southeast Asia and other countries or regions |
|      | 25090105     | HYC-GDFJHH-17AWG-RB-SM | hybrid cable,Indoor,LSZH,Black,GDFJHH-2G. 657A2+2*17AWG(UL3385),17AWG,Red,Blue Sub-power cable, 1.6mm,7.8mm, 2cores,Single mode, 9/125   | -              | -      | IEC 60332-1, IEC 60332-3-24, GB 31247 B1, CPR: B2ca-s1, d1, a1 | 39mm        | -20°C to 75°C         | China   |

| Type | Part Number  | Model                    | Description  | Connector Type | Length | Flame Resistance Rating  | Bend Radius | Operating Temperature | Applicable Country/Region |
|------|--------------|--------------------------|--|----------------|--------|--|-------------|-----------------------|---------------------------|
|      | 25090105-001 | HYC-GDFJH H-17A WG-RW-SM | hybrid cable,Indoor,LSZH,Black,GDFJHH-2G. 657A2+2*17AWG(UL3385), 17AWG,Red,White Sub-power cable, 1.6mm,7.8mm, 2cores,Single mode, 9/125 | -              | -      | IEC 60332-1, IEC 60332-3-24, GB 31247 B1, CPR: B2ca-s1, d1, a1 | 39mm        | -20°C to 75°C         | Europe                    |
|      | 25090106     | HYC-GDFJH H-21A WG-RB-SM | hybrid cable,Indoor,LSZH,Black,GDFJHH-2G. 657A2+2*21AWG(UL3385),21AWG,Red,Blue Sub-power cable, 1.6mm,9.1mm, 2cores,Single mode, 9/125   | -              | -      | IEC 60332-1, IEC 60332-3-24, GB 31247 B1, CPR: B2ca-s1, d1, a1 | 35.5mm      | -20°C to 75°C         | China                     |

| Type                | Part Number  | Model                    | Description  | Connector Type | Length | Flame Resistance Rating  | Bend Radius | Operating Temperature | Applicable Country/Region                     |
|---------------------|--------------|--------------------------|--|----------------|--------|--|-------------|-----------------------|---|
|                     | 25090106-001 | HYC-GDFJH H-21A WG-RW-SM | hybrid cable,Indoor,LSZH,Black,GDFJHH-2G. 657A2+2*21AWG(UL3385), 21AWG,Red,White Sub-power cable, 1.6mm,7.1mm, 2cores,Single mode, 9/125 | -              | -      | IEC 60332-1, IEC 60332-3-24, GB 31247 B1, CPR: B2ca-s1, d1, a1 | 35.5mm      | -20°C to 75°C         | Europe  |
| Switch-side pigtail | 04170005     | PDLC-1.2m-ODF-CN         | Hybrid Cable Assembly,1P1F, 1.2m,PDLC/UPC,GDFJVV-2G. 657A2+2*17AWG,,Red,Blue,Switch  | PDL C/U PC     | 1.2m   | IEC60332-3-24  | 31mm        | -20°C to 75°C         | China   |
|                     | 04170017     | PDLC-1.2m-ODF-SEA        | Hybrid Cable Assembly,1P1F, 1.2m,PDLC/UPC,GDFJVV-2G. 657A2+2*17AWG,,Black,Blue,Switch  | PDL C/U PC     | 1.2m   | IEC60332-3-24  | 31mm        | -20°C to 75°C         | Southeast Asia and other countries or regions |

| Type                     | Part Number  | Model             | Description   | Connector Type           | Length | Flame Resistance Rating | Bend Radius | Operating Temperature | Applicable Country/Region                     |
|--------------------------|--------------|-------------------|---|--------------------------|--------|-------------------------|-------------|-----------------------|---|
|                          | 04170024     | PDLC-1.2m-ODF-EUR | Hybrid Cable Assembly,1P1F,1.2m,PDLC/UPC,GDFJHH-2G.657A2+2*17AWG,,Red,White,Switch  | PDL C/U PC               | 1.2m   | IEC60332-3-24           | 39mm        | -20°C to 75°C         | Europe  |
| A P-si d e p i g t a i l | 04170006-001 | PDLC-0.4m-AP-CN   | Hybrid Cable Assembly,1P1F,0.4m,PDLC/UPC,GDFJV-2G.657A2+2*17AWG,,Red,Blue,AP        | PDL C/U PC               | 0.4m   | IEC60332-3-24           | 31mm        | -20°C to 75°C         | China   |
|                          | 04170018-001 | PDLC-0.4m-AP-SEA  | Hybrid Cable Assembly,1P1F,0.4m,PDLC/UPC,GDFJV-2G.657A2+2*17AWG,,Black,Blue,AP      | PDL C/U PC               | 0.4m   | IEC60332-3-24           | 31mm        | -20°C to 75°C         | Southeast Asia and other countries or regions |
|                          | 04170023-001 | PDLC-0.4m-AP-EUR  | Hybrid Cable Assembly,1P1F,0.4m,PDLC/UPC,GDFJHH-2G.657A2+2*17AWG,,Red,White,AP      | PDL C/U PC               | 0.4m   | IEC60332-3-24           | 39mm        | -20°C to 75°C         | Europe  |
|                          | 04170003     | PDLC-PDLC-0.3m-CN | Hybrid Cable Assembly,1P1F,0.3m,PDLC/UPC,2G.657A2+2*17AWG,PDL C/UPC,Red,Blue,Switch | PDL C/U PC to PDL C/U PC | 0.3m   | IEC60332-3-24           | 20mm        | -20°C to 75°C         | China   |

| Type | Part Number  | Model                  | Description  | Connector Type              | Length | Flame Resistance Rating | Bend Radius | Operating Temperature | Applicable Country/Region |
|------|--------------|------------------------|--|-----------------------------|--------|-------------------------|-------------|-----------------------|---------------------------|
|      | 04170001     | PDLC-PDLC-3.0m-CN      | Hybrid Cable Assembly,1P1F,3m,PDLC/UPC,GDFJVV-2G.657A2+2*17AWG,PDLC/UPC,Red,Blue,Switch      | PDL C/U PC to PDL C/U PC    | 3.0m   | IEC60332-3-24           | 31m         | -20°C to 75°C         | China                     |
|      | 04170001-001 | PDLC-PDLC-7.0m-CN      | Hybrid Cable Assembly,1P1F,7m,PDLC/UPC,GDFJVV-2G.657A2+2*17AWG,PDLC/UPC,Red,Blue,Switch      | PDL C/U PC to PDL C/U PC    | 7.0m   | IEC60332-3-24           | 31m         | -20°C to 75°C         | China                     |
|      | 04170001-002 | PDLC-PDLC-1.5m-CN      | Hybrid Cable Assembly,1P1F,1.5m,PDLC/UPC,GDFJVV-2G.657A2+2*17AWG,PDLC/UPC,Red,Blue,Switch    | PDL C/U PC to PDL C/U PC    | 1.5m   | IEC60332-3-24           | 31m         | -20°C to 75°C         | China                     |
|      | 04170004     | PDLC-DLC+PRJ45-0.3m-CN | Hybrid Cable Assembly,1P1F,0.3m,PDLC/UPC,2G.657A2+2*17AWG,PRJ45+DLC/UPC,Red,Blue,Switch      | PDL C/U PC to PRJ45+DLC/UPC | 0.3m   | IEC60332-3-24           | 20m         | -20°C to 75°C         | China                     |
|      | 04170002     | PDLC-DLC+PRJ45-3.0m-CN | Hybrid Cable Assembly,1P1F,3m,PDLC/UPC,GDFJVV-2G.657A2+2*17AWG,PRJ45+DLC/UPC,Red,Blue,Switch | PDL C/U PC to PRJ45+DLC/UPC | 3.0m   | IEC60332-3-24           | 31m         | -20°C to 75°C         | China                     |



| Type | Part Number   | Model                  | Description  | Connector Type              | Length | Flame Resistance Rating | Bend Radius | Operating Temperature | Applicable Country/Region                     |
|------|---------------|------------------------|--|-----------------------------|--------|-------------------------|-------------|-----------------------|---|
|      | 0417-0002-001 | PDLC-DLC+PRJ45-7.0m-CN | Hybrid Cable Assembly,1P1F,7m,PDLC/UPC,GDFJVV-2G.657A2+2*17AWG,PRJ45+DLC/UPC,Red,Blue,Switch   | PDL C/U PC to PRJ45+DLC/UPC | 7.0m   | IEC60332-3-24           | 31m         | -20°C to 75°C         | China   |
|      | 0417-0002-002 | PDLC-DLC+PRJ45-1.5m-CN | Hybrid Cable Assembly,1P1F,1.5m,PDLC/UPC,GDFJVV-2G.657A2+2*17AWG,PRJ45+DLC/UPC,Red,Blue,Switch | PDL C/U PC to PRJ45+DLC/UPC | 1.5m   | IEC60332-3-24           | 31m         | -20°C to 75°C         | China   |
|      | 0417-0015     | PDLC-PDLC-0.3m-SEA     | Hybrid Cable Assembly,1P1F,0.3m,PDLC/UPC,2G.657A2+2*17AWG,PDL C/UPC,Black,Blue,Switch          | PDL C/U PC to PDL C/U PC    | 0.3m   | IEC60332-3-24           | 20m         | -20°C to 75°C         | Southeast Asia and other countries or regions |

| Type | Part Number   | Model              | Description   | Connector Type           | Length | Flame Resistance Rating | Bend Radius | Operating Temperature | Applicable Country/Region                     |
|------|---------------|--------------------|---|--------------------------|--------|-------------------------|-------------|-----------------------|---|
|      | 0417-0013-002 | PDLC-PDLC-1.5m-SEA | Hybrid Cable Assembly,1P1F,7m,PDLC/UPC,GDFJVV-2G.657A2+2*17AWG,PDLC/UPC,Black,Blue,Switch | PDL C/U PC to PDL C/U PC | 1.5m   | IEC60332-3-24           | 31mm        | -20°C to 75°C         | Southeast Asia and other countries or regions |
|      | 0417-0013-001 | PDLC-PDLC-3.0m-SEA | Hybrid Cable Assembly,1P1F,3m,PDLC/UPC,GDFJVV-2G.657A2+2*17AWG,PDLC/UPC,Black,Blue,Switch | PDL C/U PC to PDL C/U PC | 3.0m   | IEC60332-3-24           | 31mm        | -20°C to 75°C         | Southeast Asia and other countries or regions |
|      | 0417-0013     | PDLC-PDLC-7.0m-SEA | Hybrid Cable Assembly,1P1F,7m,PDLC/UPC,GDFJVV-2G.657A2+2*17AWG,PDLC/UPC,Black,Blue,Switch | PDL C/U PC to PDL C/U PC | 7.0m   | IEC60332-3-24           | 31mm        | -20°C to 75°C         | Southeast Asia and other countries or regions |

| Type | Part Number   | Model                   | Description  | Connector Type              | Length | Flame Resistance Rating | Bend Radius | Operating Temperature | Applicable Country/Region                     |
|------|---------------|-------------------------|--|-----------------------------|--------|-------------------------|-------------|-----------------------|---|
|      | 0417-0014-002 | PDLC-DLC+PRJ45-1.5m-SEA | Hybrid Cable Assembly,1P1F,1.5m,PDLC/UPC,GDFJVV-2G.657A2+2*17AWG,PRJ45+DLC/UPC,Black,Blue,Switch | PDL C/U PC to PRJ45+DLC/UPC | 1.5m   | IEC60332-3-24           | 31mm        | -20°C to 75°C         | Southeast Asia and other countries or regions |
|      | 0417-0014-001 | PDLC-DLC+PRJ45-3.0m-SEA | Hybrid Cable Assembly,1P1F,3m,PDLC/UPC,GDFJVV-2G.657A2+2*17AWG,PRJ45+DLC/UPC,Black,Blue,Switch   | PDL C/U PC to PRJ45+DLC/UPC | 3.0m   | IEC60332-3-24           | 31mm        | -20°C to 75°C         | Southeast Asia and other countries or regions |
|      | 0417-0014     | PDLC-DLC+PRJ45-7.0m-SEA | Hybrid Cable Assembly,1P1F,7m,PDLC/UPC,GDFJVV-2G.657A2+2*17AWG,PRJ45+DLC/UPC,Black,Blue,Switch   | PDL C/U PC to PRJ45+DLC/UPC | 7.0m   | IEC60332-3-24           | 31mm        | -20°C to 75°C         | Southeast Asia and other countries or regions |

| Type | Part Number   | Model                   | Description   | Connector Type             | Length | Flame Resistance Rating | Bend Radius | Operating Temperature | Applicable Country/Region                     |
|------|---------------|-------------------------|---|----------------------------|--------|-------------------------|-------------|-----------------------|---|
|      | 0417-0016     | PDLC-DLC+PRJ45-0.3m-SEA | Hybrid Cable Assembly,1P1F,0.3m,PDLC/UPC,2G.657A2+2*17AWG,PRJ45+DLC/UPC,Black,Blue,Switch   | PDL C/UPC to PRJ45+DLC/UPC | 0.3m   | IEC60332-3-24           | 20m         | -20°C to 75°C         | Southeast Asia and other countries or regions |
|      | 0417-0021     | PDLC-PDLC-0.3m-EUR      | Hybrid Cable Assembly,1P1F,0.3m,PDLC/UPC,2G.657A2+2*17AWG,PDL C/UPC,Red,White,Switch        | PDL C/UPC to PDL C/UPC     | 0.3m   | IEC60332-3-24           | 20m         | -20°C to 75°C         | Europe  |
|      | 0417-0019-002 | PDLC-PDLC-1.5m-EUR      | Hybrid Cable Assembly,1P1F,1.5m,PDLC/UPC,GDFJHH-2G.657A2+2*17AWG,PDL C/UPC,Red,White,Switch | PDL C/UPC to PDL C/UPC     | 1.5m   | IEC60332-3-24           | 39m         | -20°C to 75°C         | Europe  |
|      | 0417-0019-001 | PDLC-PDLC-3.0m-EUR      | Hybrid Cable Assembly,1P1F,3m,PDLC/UPC,GDFJHH-2G.657A2+2*17AWG,PDL C/UPC,Red,White,Switch   | PDL C/UPC to PDL C/UPC     | 3.0m   | IEC60332-3-24           | 39m         | -20°C to 75°C         | Europe  |

| Type | Part Number   | Model                   | Description   | Connector Type              | Length | Flame Resistance Rating | Bend Radius | Operating Temperature | Applicable Country/Region |
|------|---------------|-------------------------|---|-----------------------------|--------|-------------------------|-------------|-----------------------|---------------------------|
|      | 0417-0019     | PDLC-7.0m-EUR           | Hybrid Cable Assembly,1P1F,7m,PDLC/UPC,GDFJHH-2G.657A2+2*17AWG,PDLC/UPC,Red,White,Switch        | PDL C/U PC to PDL C/U PC    | 7.0m   | IEC60332-3-24           | 39mm        | -20°C to 75°C         | Europe                    |
|      | 0417-0020-002 | PDLC-DLC+PRJ45-1.5m-EUR | Hybrid Cable Assembly,1P1F,1.5m,PDLC/UPC,GDFJHH-2G.657A2+2*17AWG,PRJ45+DLC/UPC,Red,White,Switch | PDL C/U PC to PRJ45+DLC/UPC | 1.5m   | IEC60332-3-24           | 39mm        | -20°C to 75°C         | Europe                    |
|      | 0417-0020-001 | PDLC-DLC+PRJ45-3.0m-EUR | Hybrid Cable Assembly,1P1F,3m,PDLC/UPC,GDFJHH-2G.657A2+2*17AWG,PRJ45+DLC/UPC,Red,White,Switch   | PDL C/U PC to PRJ45+DLC/UPC | 3.0m   | IEC60332-3-24           | 39mm        | -20°C to 75°C         | Europe                    |
|      | 0417-0020     | PDLC-DLC+PRJ45-7.0m-EUR | Hybrid Cable Assembly,1P1F,7m,PDLC/UPC,GDFJHH-2G.657A2+2*17AWG,PRJ45+DLC/UPC,Red,White,Switch   | PDL C/U PC to PRJ45+DLC/UPC | 7.0m   | IEC60332-3-24           | 39mm        | -20°C to 75°C         | Europe                    |
|      | 0417-0022     | PDLC-DLC+PRJ45-0.3m-EUR | Hybrid Cable Assembly,1P1F,0.3m,PDLC/UPC,2G.657A2+2*17AWG,PRJ45+DLC/UPC,Red,White,Switch        | PDL C/U PC to PRJ45+DLC/UPC | 0.3m   | IEC60332-3-24           | 20mm        | -20°C to 75°C         | Europe                    |